

MULTI-PURPOSE BLAST CHILLER EVOLUTION



INSTRUCTION MANUAL

MULTI-PURPOSE BLAST CHILLER EVOLUTION

English

General instructions

1 - GENERAL INFORMATION	6
2 - TECHNICAL ASSISTANCE	7
3 - IDENTIFICATION & MARKINGS	7
4 - IDENTIFICATION OF PARTS	8
5 - RISK ANALYSIS	9
6 - UNPACKING	10
7 - POSITIONING	10
8 - POWER CONNECTION	10
9 - WATER NETWORK CONNECTION (1HUNDRED)	11
10 - INTENDED USE	11
11 - RULES OF USE	14
12 - CLEANING	15
13 - MACHINE DISPOSAL	15

Operating instructions

14 - INTERFACE AND CYCLES	15
15 - FOOD PROBE	17
16 - OPERATING CYCLES	18
16.1 - STARTUP	21
16.2 - SHUTDOWN	22
16.3 - FOOD FAMILY SELECTION	23
16.4 - AUTOMATIC BLAST CHILLING CYCLE	25
16.5 - CUSTOM BLAST CHILLING CYCLE	27
16.6 - MANUAL BLAST CHILLING CYCLE	33
16.7 - AUTOMATIC SHOCK FREEZING CYCLE	39
16.8 - CUSTOM SHOCK FREEZING CYCLE	41
16.9 - MANUAL SHOCK FREEZING CYCLE	47
16.10 - AUTOMATIC THAWING CYCLE	53
16.11 - CUSTOM THAWING CYCLE	55
16.12 - MANUAL THAWING CYCLE	61
16.13 - CUSTOM PROVING CYCLE	67
16.14 - PROVING MANUAL CYCLE	73
16.15 - AUTOMATIC SLOW COOKING CYCLE	79
16.16 - CUSTOM SLOW COOKING CYCLE	81
16.17 - SLOW COOKING MANUAL CYCLE	87
16.18 - COMBY CYCLE	93
16.19 - MULTILEVEL FUNCTION	100
16.20 - FUNCTIONS AVAILABLE DURING A CYCLE	102
16.21 - 1HUNDRED - HUMIDITY MANAGEMENT AND 100°C SLOWCOOKING	105

Options

17 - OPTION MENU	107
17.1 - EXTRACTION	108
17.2 - HACCP	110
17.3 - ALARMS	113
17.4 - INFO	115

17.6 - USB	119
17.6.1 - EXPORT HACCP	120
17.6.2 - EXPORT SETUP	122
17.6.3 - IMPORT SETUP	124
17.6.4A - UPDATE TOUCH SCREEN	126
17.6.4B - UPDATE SOFTWARE	128
17.7 - HELP	132
17.8 - LANGUAGE	134
17.9 - DEFROST	135
17.10 - I/O	137
17.11 - TIME	139
17.12 - PASSWORD	141

Troubleshooting

18- ALARMS LIST	145
-----------------	-----

General instructions

1 - GENERAL INFORMATION

The precautions listed in this documentation provide important instructions regarding the safety, operation and servicing of the equipment.

To ensure maximum safety, hygiene and performance, it is recommended to carefully file all documentation near the equipment and to deliver it to technicians and operators responsible for its use.

The choice of materials and manufacture of products complies with EC safety directives. Moreover, complete testing of all machines guarantees the quality of this equipment.

Compliance with the recommendations included in this manual is essential in order to ensure the safety of machine installation/operation and of the user.

The manufacturer, retailer and authorised service centres are available to clarify all doubts regarding the use and installation of the equipment.

The manufacturer reserves the right to make changes without any prior notice in order to make the improvements deemed necessary.

FAILURE TO COMPLY WITH THE PROVIDED INSTRUCTIONS SHALL COMPROMISE THE SAFETY OF THE EQUIPMENT AND RESULT IN THE IMMEDIATE INVALIDATION OF THE WARRANTY TERMS.

ELECTRICAL DEVICES MAY BE HAZARDOUS TO HUMAN HEALTH. CURRENT LAWS AND REGULATIONS MUST BE COMPLIED WITH DURING THE STARTUP AND USE OF SAID EQUIPMENT.

ALL INSTALLATION, MAINTENANCE, REGULATION AND REPAIR ACTIVITIES MUST BE CARRIED OUT BY QUALIFIED TECHNICIANS ONLY.

THE HIGH PERFORMANCE AND DURATION OF THE MACHINE DEPEND ON THE CORRECT EXECUTION OF ROUTINE MAINTENANCE, CARRIED OUT EVERY 4 MONTHS BY QUALIFIED TECHNICIANS.

This manual constitutes an integral part of the machine and must therefore be kept for the entire life of the equipment.

The manufacturer is released from all liability in the following circumstances:

- improper use of the machine;
- incorrect installation, not performed according to the procedures listed herein;
- defective power supply;
- serious shortcomings in the proposed maintenance schedule;
- unauthorised modifications or tampering;
- use of non-original spare parts or parts not specifically designed for the model in question;
- total or partial failure to comply with instructions.

2 - TECHNICAL ASSISTANCE

After-sales technical assistance is guaranteed by the manufacturer through its network of retailers - dealers and installers. To receive technical assistance, contact your authorised retailer and provide the details of your equipment, found on the serial ID plate.

3 - IDENTIFICATION & MARKINGS

MOD.						
CODICE CODE			MATR. S/N			
ALIMENTAZIONE RATED VOLTAGE	(V)	(Hz)	(W) (A)
SBRINAMENTO (W) DEFROSTING					
REFRIGERANTE COOLING GAS	MASSA (Kg) QUANTITY			
CLASSE CLIMATICA CLIMATIC CLASS					Max Pressure Gas
GAS ISOLAMENTO FOAMING GAS
ORDINE CONFIRM NR.			ANNO YEAR			

Example of ID plate attached to the machine.

To ensure the proper consultation of this manual, identify the model in your possession by referring to the details reported on the ID plate.

The machine is identified by the following parameters:

Serial number

Technical specifications

Year of manufacture

Machine installation and use must comply with the contents of the ID plate and data sheet..

MULTI-PURPOSE BLAST CHILLER EVOLUTION

4- IDENTIFICATION OF PARTS

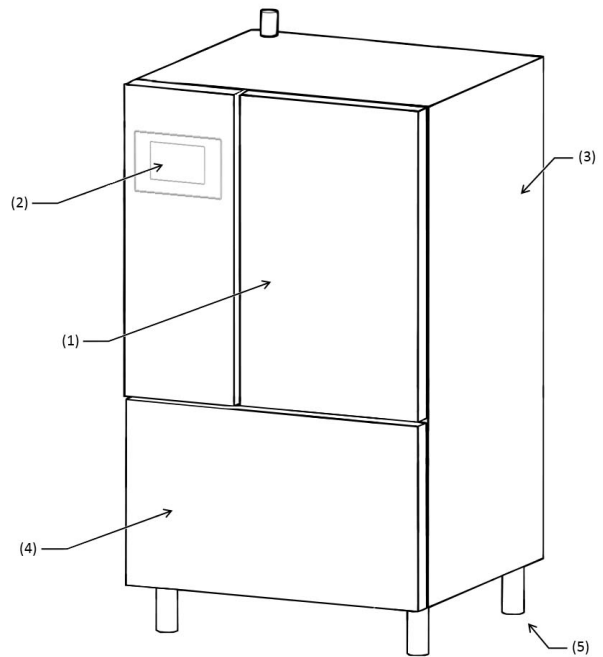
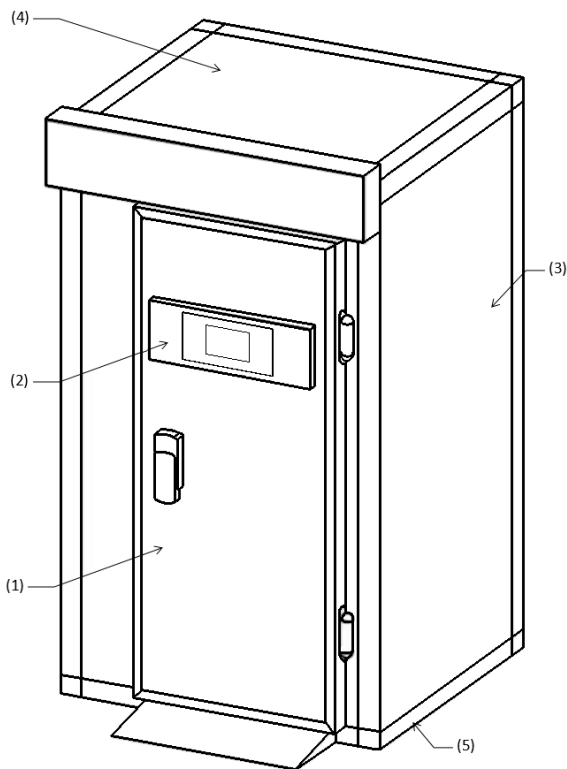
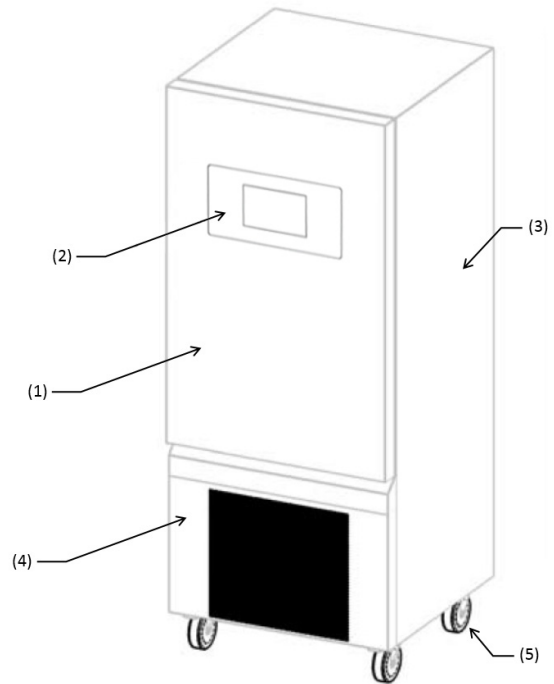
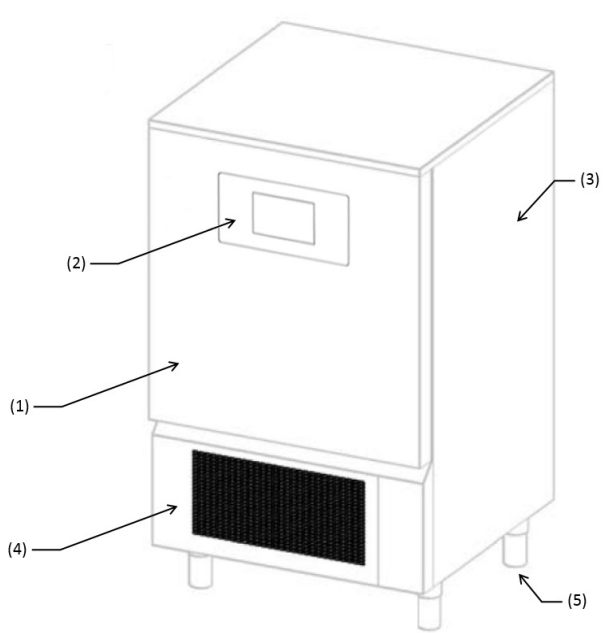

(1) DOOR	(4) MOTOR COMPARTMENT
(2) CONTROL PANEL	(5) FEET / WHEELS / BASE
(3) CHILLER COMPARTMENT	

5 - RISK ANALYSIS

List of hazards:

- Electrical parts
- Sharp parts
- Machine handling
- Fans in motion
- Refrigerant gas
- Air flows
- Non-drinking water
- Food contamination
- Inaccessible gas pipes
- Cold environments
- Hot parts

Precautions relative to hazards posed by electrical parts. Risk of electric shock, burns and fire:

- Only qualified technicians are allowed to access electrical parts.
- Do not touch the machine with damp or wet hands and feet.
- Do not use the machine with bare feet.
- Do not insert fingers or objects or tools through the grilles or air inlets.
- Do not pull on the power cord.
- Do not wash the machine with jets of water.
- Before performing maintenance or cleaning operations, disconnect the machine from the electrical power supply from the main switch and disconnect the power cord.
- In the event of flooding in the room where the machine is installed, contact an authorised service centre to perform the necessary repairs before using the machine again.
- When the machine is not being used, disconnect it from the electrical power supply.
- After the hot cycles, the internal parts and some external areas may be in temperatures above 60 ° C, do not touch the hot parts unless you use flame retardant or high temperature resistant clothing
- The door handle requires two operations to open it, follow the directions on the door for the first step to let the steam escape (do not stand nearby to avoid the flow of boiling air) and only after waiting the necessary time to proceed with the second step
- Do not obstruct the steam extraction chimney located above the machinery. Provide an extractor hood to channel the steam flow.

Precautions relative to general hazards. Risk of injury:

- Presence of sharp parts. Use protective gloves when performing any operations on the machine.
- The machine can be safely handled using suitable means, taking care to avoid damage to persons and property.
- Presence of fans in motion. Do not remove the protective grilles.
- Read the ID plate to identify the type of refrigerant gas used in the machine: the gas may be flammable.
- In the event of a flammable gas leak from the machine's cooling circuit, disconnect the power cord, open the windows to ventilate the room and immediately contact the technical service centre.
- In the event of a refrigerant gas leak, do not touch or inhale the leaking gas.
- After installing or repairing the machine, always check for any refrigerant gas leaks.
- Presence of air flows. Do not directly expose people to cold or hot air flows.
- Do not obstruct air inlets or outlets.
- Presence of non-drinking water. Do not drink the water drained by the machine.
- To avoid the contamination of food, the latter must not be brought into direct contact with the machine but rather stored in suitable containers.
- Presence of high or low temperature gas tubes. Before touching the tubes, check their temperature. Use suitable protective gloves.
- Presence of Plexy parts. Do not strike Plexy parts with force.
- In the case of anomalous noise, odours or fumes coming from the machine, disconnect the power cord and contact an authorised service centre.
- Do not install the machine in places directly exposed to salty sea air or direct sunlight

6 - UNPACKING

Before removing the packaging, make sure it is intact. If not, note any defects on the courier delivery slip before signing it. After removing the packaging, check that the device is intact; if it is damaged, promptly inform the retailer by fax or registered post, and if the damage is such that it compromises the safety of the machine, do not proceed with installation until a qualified technician has inspected the machine.

Packaging elements (plastic bags, cardboard boxes, nails, etc.) must not be left within reach of children and domestic animals insofar as they represent a hazard.

7 - POSITIONING

The machine must be installed and tested in total compliance with health and safety laws, traditional regulatory standards and current legislation. The installer must check for any restrictions imposed by local authorities.

Avoid:

- Places exposed to direct sunlight.
- Closed areas characterised by high temperatures and poor ventilation.

Remove the protective film from all sides.

To ensure the correct installation of machines with incorporated air condenser, check the installation area to ensure that air inlets necessary for the correct operation of the machine or rooms are not obstructed. Maintain a minimum distance of 50 cm from the sides where the air inlets and outlets are located.

The machine must be installed and levelled by adjusting the supporting feet, so as to guarantee its stability; all other installation solutions must be agreed to and approved by the manufacturer. Use suitable lifting means to level heavy machines.

If the equipment is not levelled, its operation and the flow of condensatation water may be compromised.

If the unit is supplied on wheels, position it in a flat area and secure it before powering the equipment.

If the machine is of modular type of cell with bottom panel placed on the floor, it is necessary to fix the bottom panel to the floor with appropriate brackets (not supplied) and to seal it using specific silicone.

If the machine is of modular type of cell with bottom panel built-in in the floor, it is necessary to provide and guarantee the air flow under and at the edges of the floor to avoid the formation of condensation water.

For the movement of the machinery, it is not recommended to incline it or to recline it. If for any reason this operation is necessary, wait 24 hours after positioning the machine before starting it up, thus allowing the oil to return to the compressor and preventing it from breaking.

The 1Hundred machine is equipped with a humidifier, this component is equipped with a water filling tank with a specific control unit for managing the water loading / unloading. To move the furniture, make sure that the water filling tray is completely empty. To empty the tank, close the water filler tap and press the down arrow button on the humidifier control unit. Once the tray has been completely emptied, make sure to put the machine on standby and proceed to disconnect the power supply. After disconnecting the water inlet and outlet pipes and after waiting at least 2 hours to allow the tray to cool down to room temperature, it will be possible to move the machinery.

8 - POWER CONNECTION

400V 3-PHASE VERSIONS OF THE EQUIPMENT ARE SUPPLIED WITHOUT A PLUG FOR CONNECTION TO THE POWER LINE.

THE MANUFACTURER SHALL NOT BE LIABLE FOR ANY CLAIMS RESULTING FROM CONNECTIONS MADE BY THE USER OR UNQUALIFIED PERSONNEL

- Check the condition of the power cord; if it is damaged, have it immediately replaced by qualified personnel.
- The electrical power supply must be compatible with the instructions reported on the machine's wiring diagram.
- To make the connection, an omnipolar main breaker switch is required, which interrupts all contacts including the neutral, with a distance between open contacts of at least 3 mm with magnetothermic trip unit and coupled with fuses, which must be dimensioned or calibrated in accordance with the power indicated on the machine plate.
- The main breaker must be located on the power line near the installation and must serve only one device at a time.
- An efficient GROUNDING system must already exist and the machinery must be connected to it.
- Adaptors, multiple plugs, incompatible wire gauges or extension cords that do not comply with current regulations, must not be used.
- For details on the electrical operating principle, see the wiring diagram supplied in the electrical panel of the equipment.
- The power cord must not be pulled or crushed during normal operation or routine maintenance.

9 - WATER NETWORK CONNECTION (1HUNDRED)

The 1Hundred model needs a connection to the water mains to perform the control functions and humidity management. The connection to the water mains must be carried out according to the manufacturer's instructions and by professionally qualified personnel.

The connection to the water mains for automatic water filling takes place via the 1/2 "male GAS connection located on the back of the machine above the condensing unit compartment.

This appliance must be supplied continuously and exclusively with non-distilled or cold water demineralized.

The operating pressure must be between 1 and 10 bar. Between the water supply and the appliance's charging connection a tap must be installed in order to interrupt the passage of water in case of need.

The water hardness recommended for correct use of the retarder cabinet must be between 16 and 20 French degrees, or between 160 and 200 mg / l of calcium carbonate. In the case of particularly hard feed water (hardness greater than 20 degrees French scale) it is recommended to install a softener between the filling tap and the inlet on the humidifier, while the presence of solid elements, for example sand, can be eliminated. by installing a mechanical filter which must be inspected and cleaned periodically as foreseen by the manufacturer of the same.

The appliance also needs to be connected to a drain, this connection ensures both that in the event of a malfunction the excess water is disposed of and the automatic drain of the humidifier container to avoid the formation of deposits that could affect operation. The connection to the drain must be made through a 1/2 "GAS male fitting. The drain hose must not be constricted or create pressure, in which case it is essential to insert a breather on the drain line.

Connect the drain only with pipes suitable for temperatures not lower than 100 ° C, with a diameter not lower than 25 mm; do not exceed the height of the unloading on the machinery at any point on the line.

NEVER RUN THE HUMIDIFIER WITHOUT THE DRAIN LINE CONNECTED CORRECTLY.
DO NOT PERFORM CHOKES, TRAPS OR LENGTHS GREATER THAN 5 METERS.

10 - INTENDED USE

Blast chillers and shock freezers are machineries used to rapidly cool food, both to prevent the spread of food bacteria and to maintain the qualities, flavour, aromas and texture of chilled food.

These machines are used in three distinct ways:

- Blast chilling of food down to +3°C.
- Freezing of food down to -18°C.
- Thawing of food up to max +10°C.

Machineries defined as ALL IN ONE and 1HUNDRED can also be used for the following purposes:

- Slow cooking at low temperature
- Proving

The machine defined as 1HUNDRED also allows for the management of humidity in the cell.

Blast chiller users can set the cooling or cooking cycle most suited to the food being handled.

At the end of their cycle, blast chillers and shock freezers can also store food at a constant temperature, but only for a limited time, at most for two days.

These machines are in fact not temperature maintaining devices.

For the proving and cooking cycles, it is recommended not to exceed 24 hours of preservation.

11 - RULES OF USE

- Do not stack foods that need to be blast chilled and/or frozen.
- Do not exceed the declared number of kilograms and distribute the product evenly in the trays.
- Blast chilling and shock freezing times always refer to products with a maximum thickness of 40 mm.
- After selecting the blast chilling or the shock freezing cycle, wait about 30 minutes before the start of the cycle, so as to allow the machine to correctly perform the precooling of the chamber.
- After selecting the slow cooking cycle, wait about 30 minutes before the start of the cycle, so as to allow the machine to correctly perform the preheating of the chamber.
- Blast chill only one type of food at a time; different foods have different densities and therefore cycle execution times may vary.
- The core probe must be correctly positioned at the centre of the largest piece of the product, and the tip must never exit the product and/or touch the tray.
- To prevent the core probe from breaking, do not insert it into foods characterised by a temperature higher than 100°C.
- The core probe must always be cleaned after use to avoid malfunctioning.
- Do not cover foods with a lid or other object; the more isolated the product is, the more time will be needed for blast chilling
- If foods are inserted with a temperature greater than 70°C, the machine may be overloaded, increasing blast chilling times and power consumption.
- Do not obstruct the ventilation air inlets.
- The water drip tray in the blast cell must be positioned under the equipment in the dedicated tracks.
- Make sure the drain pipe is positioned inside the drip tray and free it from any obstructions.
- The drip tray must be regularly emptied; to do so, simply extract the tray from the tracks, empty it and re-insert it back into the tracks.
- For climate class 5 equipment, EN 60335-2-89 conformity tests (chapters 10, 11, 13) are performed at a room temperature of 43°C ±2°C.
- The machineries with incorporated condensing unit are not built-in devices.
- Do not store explosive substances, such as pressurised containers with flammable propellants, in this device.
- Do not obstruct the steam vent located above the 1Hundred machine. Also provide for an extractor hood of sufficient size to extract the steam.

Below is the table relating to the energy consumption of the various models of blast chillers and freezers tested in accordance with EN 17032

Chart according to EN 17032

MODEL	SIMILAR MODEL	Nr. trays / chilling according to EN 17032	Nr. trays / freezing according to EN 17032	Test trays	Climate class according to EN 60335-2-89	Multifunction	Cooling capacity according to EN 17032				Power consumption according to EN 17032				Gas
							Cycle chilling from +65°C to +10°C freezing from +65°C to -18°C	Chilling full load capacity	Freezing full load capacity	Chilling [minutes]	Freezing [minutes]	Chilling [kg]	Freezing [kg]	Chilling [kWh/cycle]	
INFINITY 5		5	2	GN, EN	3, 4, 5	YES, NOT	110	270	25	10	2,08	4,96	0,08	0,50	R452A GWP 2141
INFINITY 5 2/1		7	2	GN	5	YES	120	270	35	10	2,8	6,2	0,08	0,62	R452A GWP 2141
INFINITY 8		7	3	GN	5	YES	120	270	35	15	2,76	6,16	0,08	0,41	R452A GWP 2141
INFINITY 10	& INFINITY 10 RAT	8	4	GN	5	YES	120	270	40	20	1,36	2,46	0,03	0,12	R452A GWP 2141
1HUNDRED		14	6	GN	5	YES	120	270	70	30	3,3	6,5	0,05	0,22	R452A GWP 2141
INFINITY 10 2/1		14	6	GN	5	YES	120	270	70	30	3,3	6,5	0,05	0,22	R452A GWP 2141
INFINITY 15		14	6	GN	5	YES	120	253	70	30	1,87	3,45	0,03	0,12	R452A GWP 2141
SPEED 5S		2	1	GN	5	NOT	100	266	10	5	1,19	2,89	0,12	0,58	R452A GWP 2141
SPEED 5	& FASTER 5	3	1	GN	5	NOT	106	270	15	5	1,3	2,46	0,09	0,49	R452A GWP 2141
SPEED 8		4	2	GN	5	NOT	120	270	20	10	2,5	5,8	0,13	0,58	R452A GWP 2141
SPEED 10	& FASTER 10	6	2	GN	5	NOT	120	270	30	10	1,4	2,1	0,05	0,21	R452A GWP 2141
SPEED 15	& FASTER 15	8	3	GN	5	NOT	98	262	40	15	1,59	2,3	0,04	0,15	R452A GWP 2141
FASTER 3		2	1	GN	5	NOT	81	263	10	5	1,15	2,72	0,11	0,54	R452A GWP 2141

Cycle test:

Manual chilling: minutes 300 / temperature -20°C / ventilation 10

Manual freezing: minutes 300 / temperature -40°C / ventilation 10

12 - CLEANING

DO NOT USE JETS OF PRESSURISED WATER OR STEAM.

CLEANING THE EXTERNAL UNIT

The external unit must be cleaned with a damp cloth moistened with a water and bicarbonate solution, or other neutral detergents, and dried with a soft cloth.

CLEANING THE DISPLAY

The display must be cleaned with a clean, soft cloth (free of powders and slag), moistened with water and soap or water and alcohol at a maximum of 10%. Other detergents or dirty and dry cloths may ruin the material. Dry with a soft, clean cloth.

CLEANING THE INTERNAL COMPARTMENT

Remove the trays, grilles and tracks that can be cleaned like the internal compartment, clean with a damp cloth moistened in a water and bicarbonate solution, or other neutral detergents, and dry with a soft cloth.

CLEANING THE CORE PROBE

Each time the blast chiller is used together with the core probe, the latter must be cleaned with a damp sponge moistened with a water and bicarbonate solution.

CLEANING THE CONDENSER (MAINTENANCE)

To ensure the machine's correct operation, the condenser must be kept clean to ensure the free circulation of air. This operation must be performed every 120 days at most. The condenser must be cleaned with a soft-bristle brush so as to remove all dust and fluff deposited on the condenser fan blades.

Alternatively, it is preferable to use a vacuum cleaner to prevent the spread of dust into the atmosphere.

In the case of oil deposits, it is recommended to remove them using a brush dipped in alcohol.

STEAM CYLINDER CLEANING (1HUNDRED)

For a correct production of steam, clean the steam cylinder at least every 10 months.

ATTENTION: NEVER REMOVE THE CYLINDER WHEN THE MACHINE IS HOT OR WITH WATER INSIDE IT. BEFORE PERFORMING THE OPERATION, COMPLETELY EMPTY THE CYLINDER WITH THE MANUAL UNLOAD BUTTON

Clean the cylinder and the filter slots using a plastic spatula and running water or with a 20% water and acetic acid solution. Carry out two or three complete washes of the cylinder by unloading with the "manual drain" button.

Check for the absence of water leaks inside the humidifier after one hour of operation from reinserting the cylinder.

13 - MACHINE DISPOSAL

Machine demolition and disposal must occur in compliance with current regulations in the country of installation, particularly in the case of the refrigerant gas and air compressor lubricant.

Materials used to build the equipment:

Stainless steel: Construction of unit

Parts in plastic: Construction of unit and other components

Refrigerant gas: In cooling circuit

Compressor oil: In cooling circuit

Copper: Electrical system and cooling circuit.



IT08020000000615

Following is the information required by users for the correct handling of electrical and electronic waste (RAEE):

- RAEE must not be disposed of as urban waste; said waste must be sorted;
- Public or private waste collection systems provided for by local laws must be used for their disposal. At the end of its useful life, the device can also be returned to the distributor if a new, equivalent device is purchased;
- This device may contain hazardous substances: improper use or incorrect disposal may have a negative impact on human health and the environment;
- The symbol (crossed-out bin on wheels) shown on the product and above, indicates that the device was released onto the market after 13th August 2005 and must be sorted separately.
- If electrical and electronic waste is incorrectly disposed of, users shall be subject to fines in accordance with current local waste disposal regulations.

Operating instructions

14 - INTERFACE AND CYCLES

The multi-purpose blast chillers are equipped with an electronic power board known as the “Controller” and an interface with a 9” resistive touch screen display with 16000000 colors, a resolution of 800x480 WVGA and 128MB of DDR RAM memory.

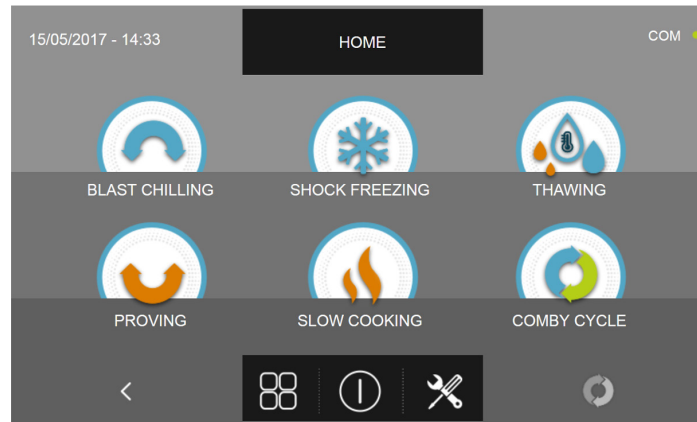

The user panel is also provided with a USB connector to transfer HACCP data, cycle SETUP and to program the display itself and the controller.

Once you have access to the HOME PAGE, the following icons will be available :



BLAST CHILLING

BLAST CHILLING : to start an automatic / custom / manual blast chilling cycle



SHOCK FREEZING

SHOCK FREEZING : to start an automatic / custom / manual shock freezing cycle



THAWING

THAWING : to start an automatic / custom / manual thawing cycle



PROVING

PROVING : to start a custom / manual proving cycle (ONLY ALL IN ONE and 1HUNDRED models)



SLOW COOKING

SLOW COOKING : to start an automatic / custom / manual slow cooking cycle (ONLY ALL IN ONE and 1HUNDRED models)



COMBY CYCLE

COMBY CYCLE : to program a sequence of the above cycles up to 6 consecutive steps.

MULTI-PURPOSE BLAST CHILLER EVOLUTION

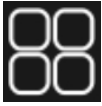

OPTION MENU:

(Models with heated probe only)



EXTRACTION

EXTRACTION : to start the food probe heating function



HACCP

HACCP : Display of HACCP charts for the performed cycles



ALARMS

Alarms : to see the list of the occurred alarms



INFO

Info : to see the information about the machinery



STERILIZATION

(Models with sterilizer only)

Sterilization : to start a sterilization cycle



USB

USB : to download the HACCP data, import/export the SETUP and update the firmware



HELP

Help : to see the demonstration video on cycles and service



LANGUAGE

Language : to set the display language



DEFROST

Defrost : to start an automatic defrosting cycle



I/O

I/O : to access the list of Input and Output with the relative values/status



TIME

Time : to set the date and time



PASSWORD

Password : to set the access and programming password

15 - FOOD PROBE

The food or core probe measures the temperature of the product in 4 different points highlighted in the figure below. To be noted that we suggest not to place the probe in products with a temperature higher than 100°C. Multipoint management is needed to detect the exact core point of the product, to understand whether the probe has been inserted into the product and which measuring points are found outside of the product itself.

The probe positioning is detected by the machine when there is a difference of at least 8°C in comparison with the cell temperature.



Available as an optional is the heated food probe. This probe has a resistor inside which, once activated by the relative cycle, allows to extract the probe from frozen food.

Available also as an optional is the multipoint wireless probe. This probe communicates wirelessly with its specific receiver the product temperature values.



MULTI-PURPOSE BLAST CHILLER EVOLUTION

16 - OPERATING CYCLES

The multi-purpose blast chiller manages multiple operating cycles, which are described in the following chapters.

During the cycles, the display shows the following information :

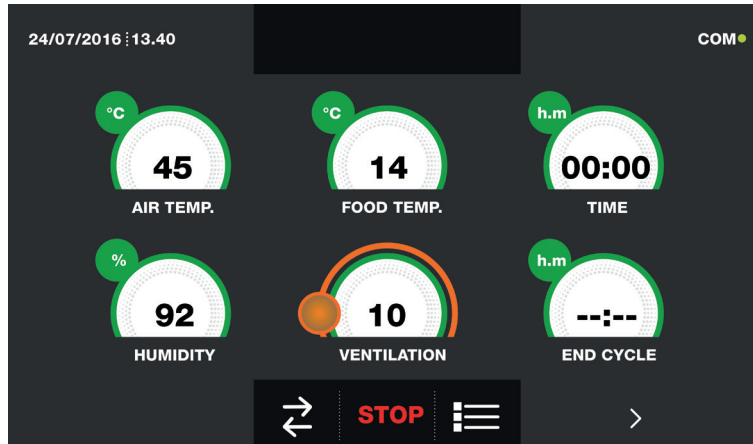

Upper section :



Current date and time, Type of cycle being executed, Communication status between the Controller and the display (com).

Lower section :



Icon to access the I/O, Icon to stop the cycle, Icon to access the machinery's parameters, Icon to access the temperature chart

Middle section :

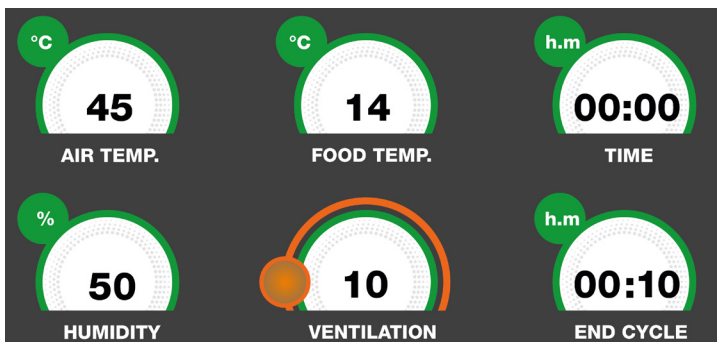

In the middle section the following information are available:

Air Temperature SET	Food probe Temperature	Elapsed Time
Humidity probe value SET	Evaporator fan speed	Time to the end of the cycle

NB. In the 1HUNDRED model the humidity probe value is managed, while it is replaced by "---" because it is not present in all the remaining models.

During a cycle, it is possible to change the evaporator fan speed value by moving the orange cursor.

If the active cycle is a temperature one (with food probe inserted), the time to the end of the cycle value will not be available. Viceversa, if the active cycle is a time one, the food temperature value will be the same as the air temperature or not available.

MULTI-PURPOSE BLAST CHILLER EVOLUTION



By pressing the icon you can access the I/O display screen, i.e. the sensors values and the status of the various main board inputs:

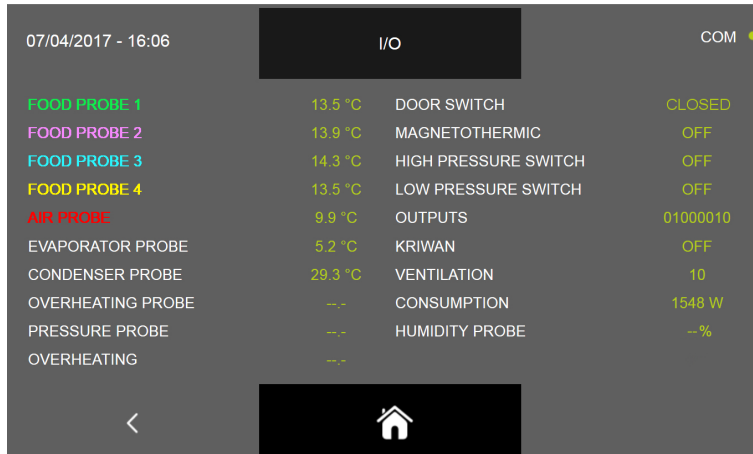

By pressing the icon you access the screen with the machinery's operating parameters (the parameters can not be modified in this section, instead they are an aid for the technical after-sales service to assess whether during a cycle you might have had any alarms or problems):

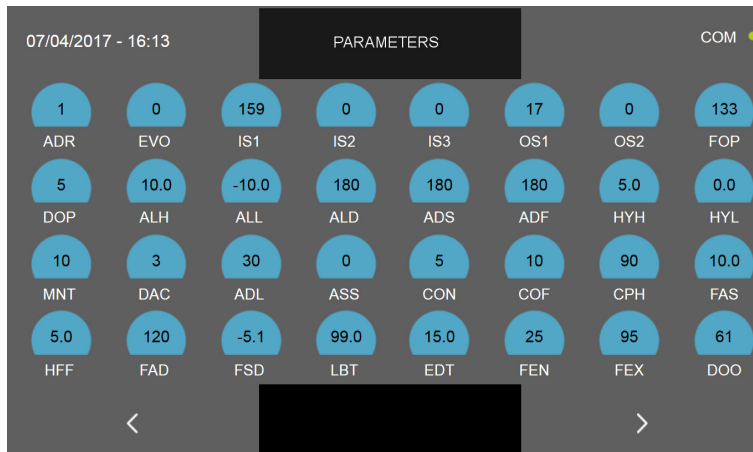

Note: The various functions will be described in detail in the chapter 16.20

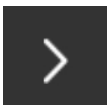

By pressing the icon you access the screen with the food temperature and cell temperature charts :

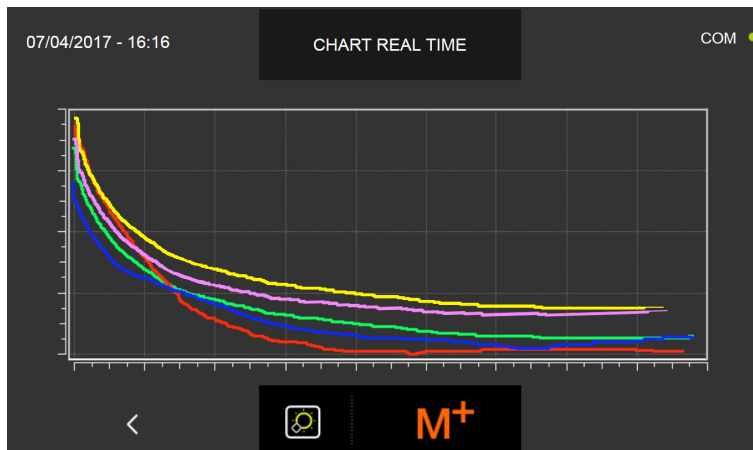

MULTI-PURPOSE BLAST CHILLER EVOLUTION



By pressing the icon  you access the screen with the setting for the MULTILEVEL function, that is the possibility to set a time value within which you will be warned by a buzzer to remove the tray for which you have set the value (the buzzer sounds with a delay of 60 seconds from the set time):

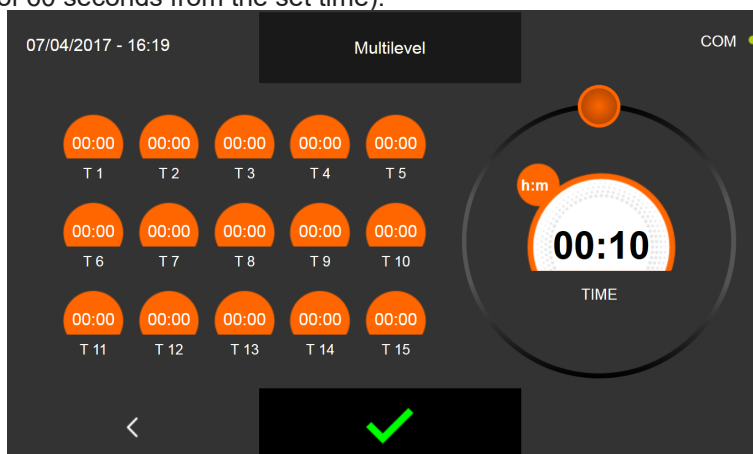

Note: The MULTILEVEL function will be explained in detail in the relative chapter 16.19

All Evolution series machines have an automatic restore function in the event of a temporary blackout:

If a cycle is running (even during the preservation phase) and a power failure occurs, when the power supply is restored, the software automatically resumes the cycle from the moment it was interrupted, completing it as from initial settings. The machine will return the “blackout ended” alarm with a red warning triangle and buzzer active for 60 seconds. If the cycle has already ended and the power failure occurs during the preservation, the software will perform 1 minute of the last active cycle and will reposition itself in storage immediately afterwards.

In the event that the power failure exceeds the duration of 6 hours, check the status of the food inside the machinery and eventually interrupt the cycle in progress manually.

DOOR HOLDING KIT

All models with built-in unit, with the exception of the 1HUNDRED, have an adjustable bracket in the lower part of the door:

- 1) By turning the lever to the shorter position, using the cooking function, it is possible to dry some foods. In fact, the humidity generated by the latter will be pushed out of the door by the fans. (in this position the door open alarm is not activated)
- 2) By turning the lever to the longest position, during periods of machine inactivity, it keeps the door open to prevent the formation of mold and bad smells, favoring a natural passage of air which dries any internal condensation.

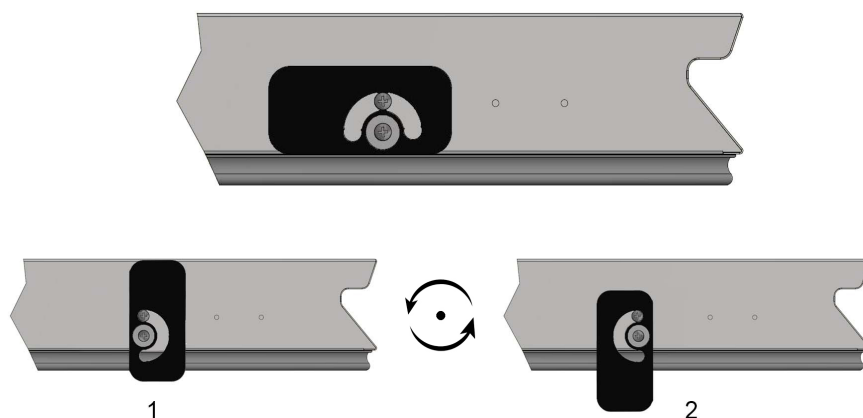

In the image above, the door is seen from the underside.

16.1 - STARTUP

When the machine is off, this is indicated by the writing STAND-BY on the display.

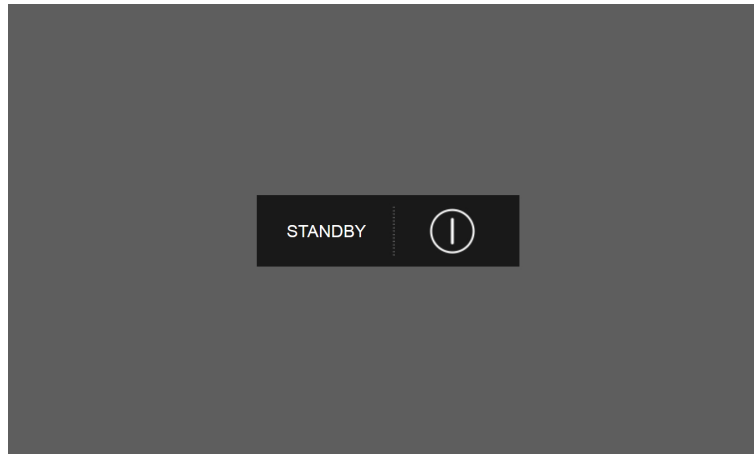

In order to access the different menu, it is necessary to press the power icon



The display will open the HOME PAGE screen, where the desired cycles can be selected.

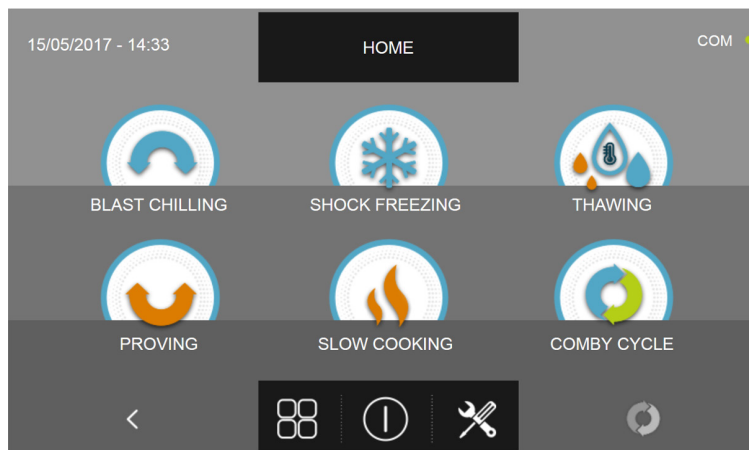

16.2 - SHUTDOWN

To turn off the machine, press the power icon in the center section of the HOME PAGE screen.

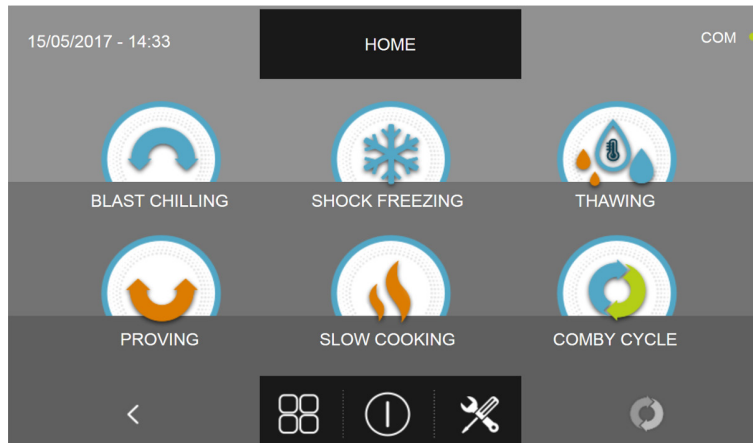

The machine will then enter the STAND-BY mode

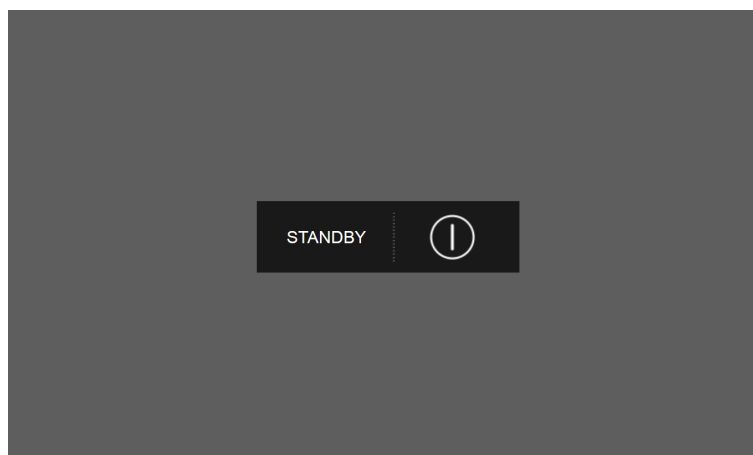

Note: By placing the machine in STAND-BY, any active alarms will be cleared.

16.3 - FOOD FAMILY SELECTION

The multi-purpose blast chiller allows the selection of three different product families: PASTRY, BAKERY and GASTRONOMY, each with their automatic cycles designed in cooperation with chefs and cooking schools. From machine in STAND-BY mode, as explained in chapter 16.1, press the start button. Once you have access to the HOME PAGE screen proceed as follows:

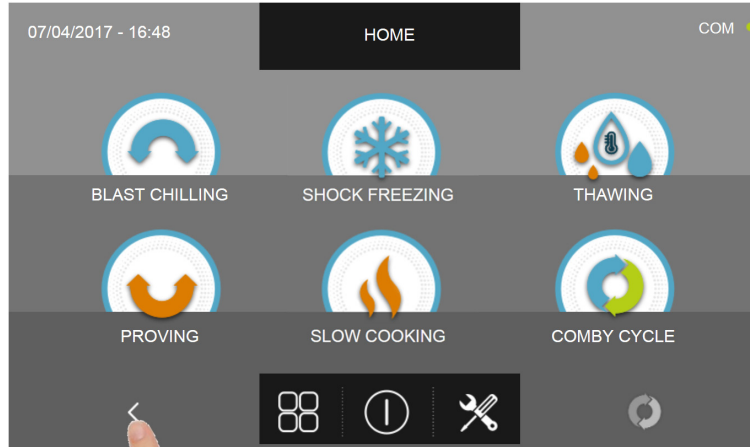

Pressing the left pointing arrow icon

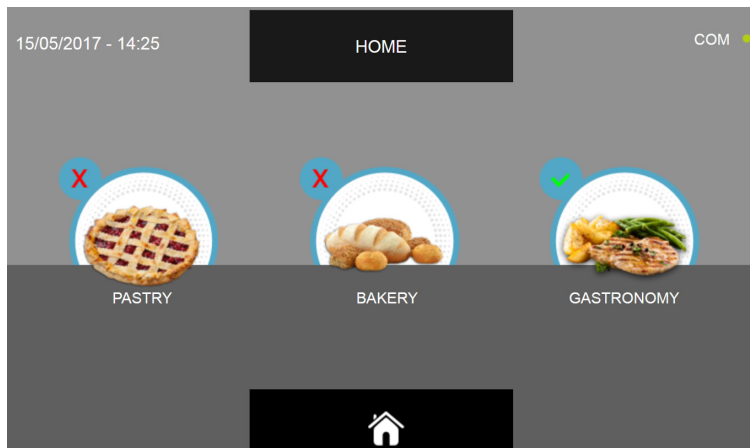

Select the desired product family (The selected icon bears a green check mark at the top left)

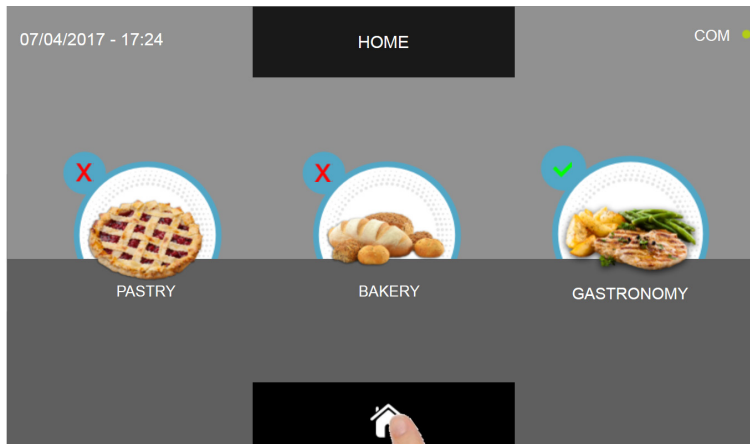

Press the icon in the picture to return to the HOME PAGE screen

MULTI-PURPOSE BLAST CHILLER EVOLUTION

The PASTRY product menu has the following food categories :

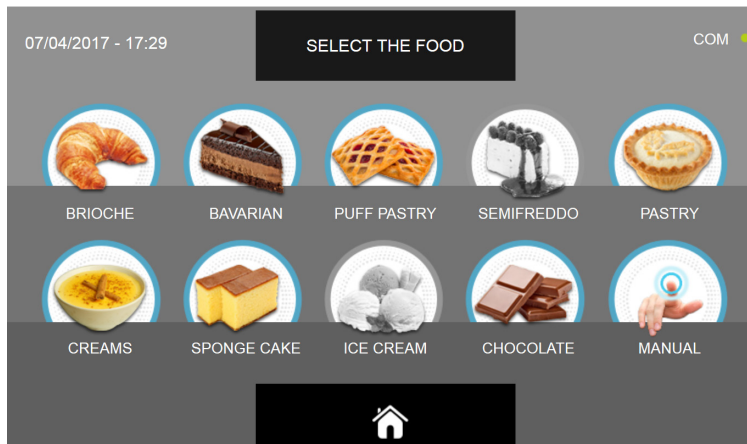

BRIOCHE
BAVARIAN
PUFF PASTRY
SEMIFREDDO (disabled)
PASTRY
CREAMS
SPONGE CAKE
ICE CREAM (disabled)
CHOCOLATE
MANUAL PROGRAM

The BAKERY product menu has the following food categories :

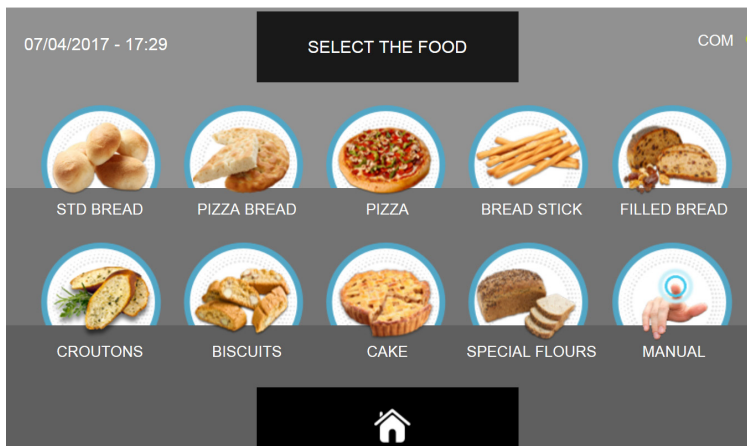

STANDARD BREAD
PIZZA BREAD
PIZZA
BREAD STICK
FILLED BREAD
CROUTONS
BISCUITS
CAKE
SPECIAL FLOURS
MANUAL PROGRAM

The GASTRONOMY product menu has the following food categories :

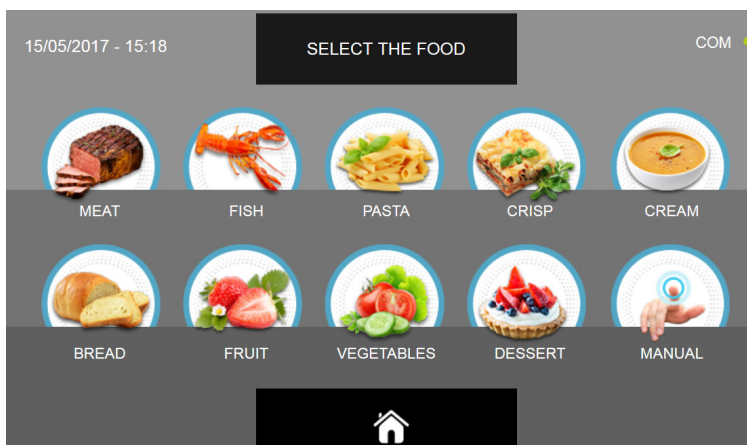

MEAT
FISH
PASTA
CRISP
CREAM
BREAD
FRUIT
VEGETABLES
DESSERT
MANUAL PROGRAM

All the product families have already set specific automatic cycles, customizable and manual cycles.

Depending on the chosen type of cycle, Blast chilling, Shock freezing, Thawing, Proving or slow cooking, some icons might be disabled (gray color) and therefore not available.

16.4 - AUTOMATIC BLAST CHILLING CYCLE

The BLAST CHILLING cycle is used to rapidly cool foods obtaining a final positive product's core temperature.

With the machinery in STAND-BY mode, press the power icon as described in chapter 16.1. Once you have access to the HOME PAGE, proceed as follows:

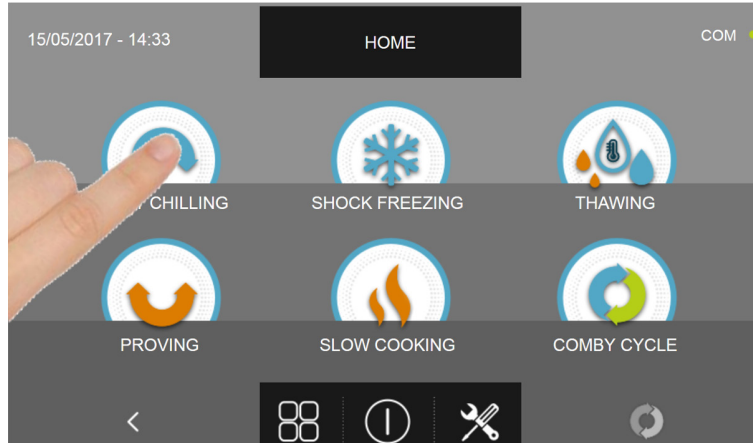

Press the BLAST CHILLING icon to access its selection menu

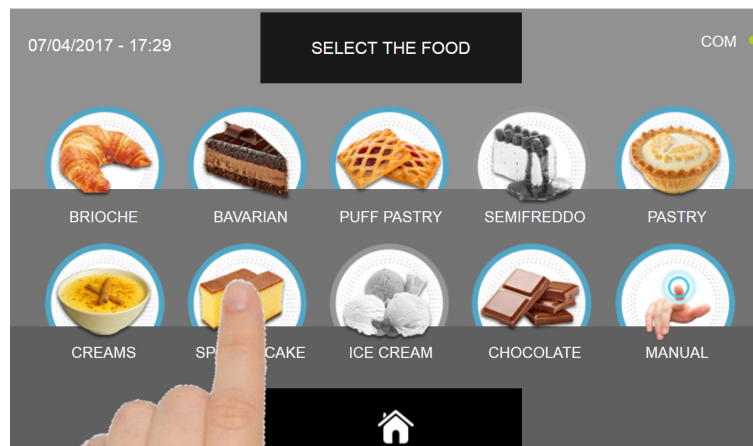

Select one of the food categories in the menu.

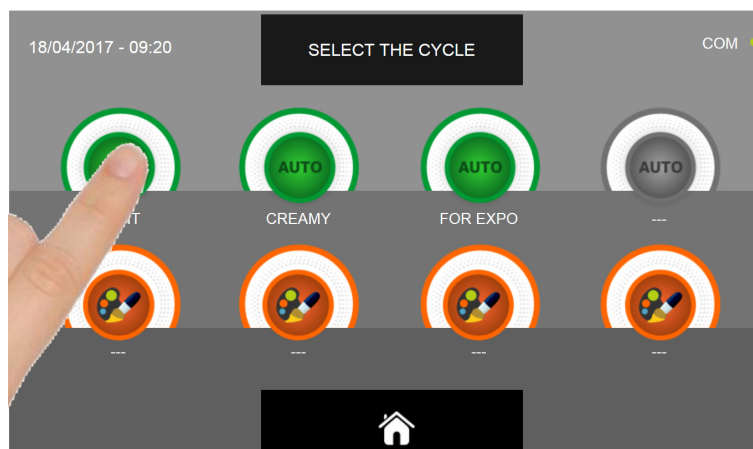

Select the green icon (AUTO) specific for the selected food.

MULTI-PURPOSE BLAST CHILLER EVOLUTION

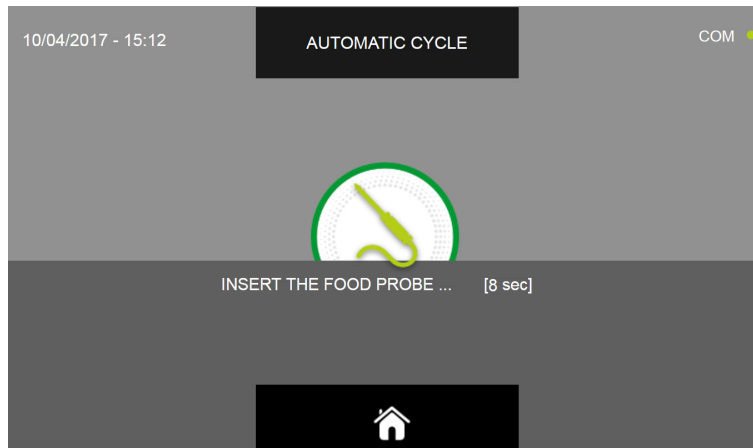

Once you have selected the type of food, you will be asked to place the food core probe. The cycle will automatically start after the probe is detected.

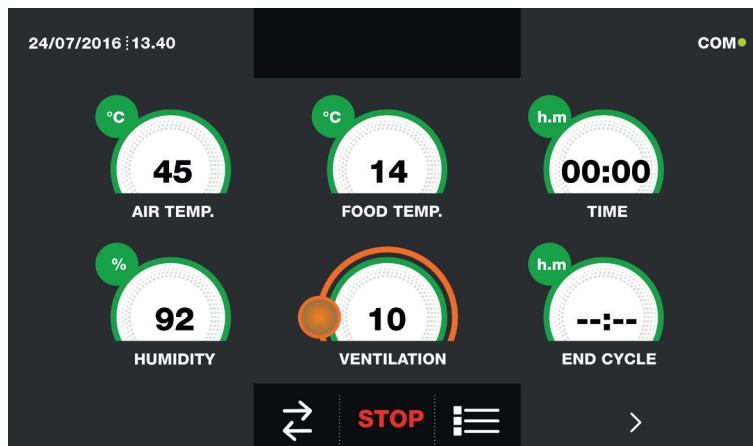

When the cycle is active, the screen with the operating data is displayed.

Refer to paragraph 15 - OPERATION CYCLES to display the temperature chart, input / output, parameter list or multilevel function.

During the cycle, by moving the cursor as shown in the figure, the ventilation value can be varied, with set $1 \div 10$:



The cycle will finish when the temperature at the core of the product will be lower or equal to the pre-set temperature. The end of the cycle will be communicated with a buzzer that emits a sound. Press on the display to silence the buzzer. Alternatively, the buzzer automatically mutes after 60 seconds. Once the cycle is finished, the machinery will automatically enter the PRESERVATION mode.

We remind you that this phase can be maintained for a maximum recommended period of 24 hours.

16.5 - CUSTOM BLAST CHILLING CYCLE

The BLAST CHILLING cycle is used to rapidly cool foods obtaining a final positive product's core temperature.

With the machinery in STAND-BY mode, press the power icon as described in chapter 16.1. Once you have access to the HOME PAGE, proceed as follows:

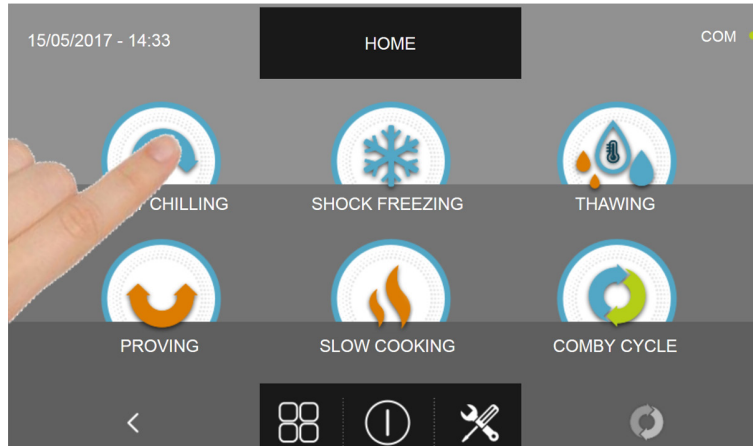

Press the BLAST CHILLING icon to access its selection menu

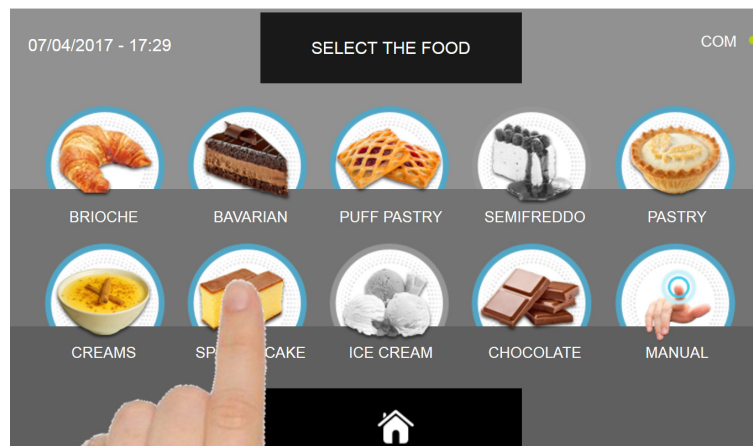

Select one of the food categories in the menu.



Select the setting icon of a CUSTOM cycle

MULTI-PURPOSE BLAST CHILLER EVOLUTION

There are two type of CUSTOM cycles :

- a- Time custom cycle (Preferred choice)
- b- Custom cycle with temperature probe

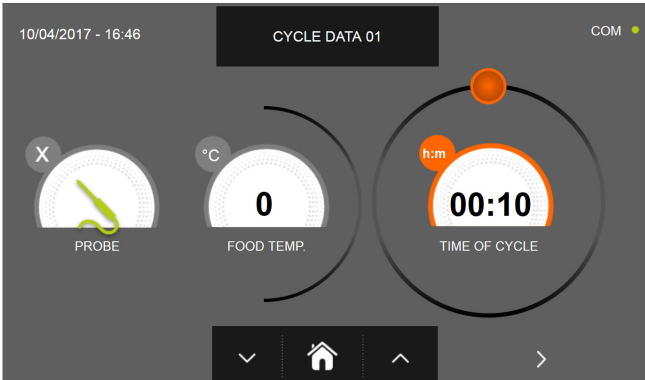

a- Time custom cycle

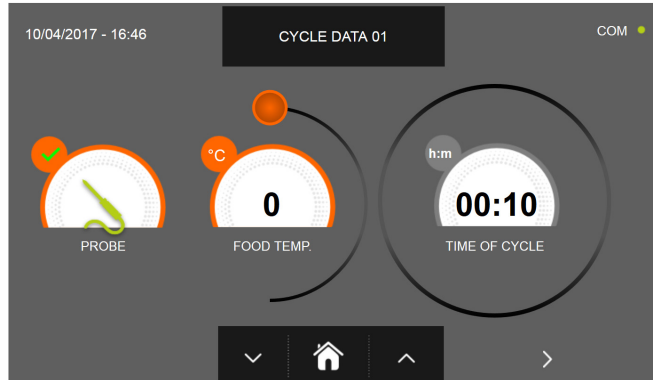

b- Custom cycle with temperature probe

N.B. To select the temperature probe cycle press the PROBE icon, to return to the time selection press the PROBE icon again.

To set the Time or Temperature values, move the cursor as shown in the following pictures :

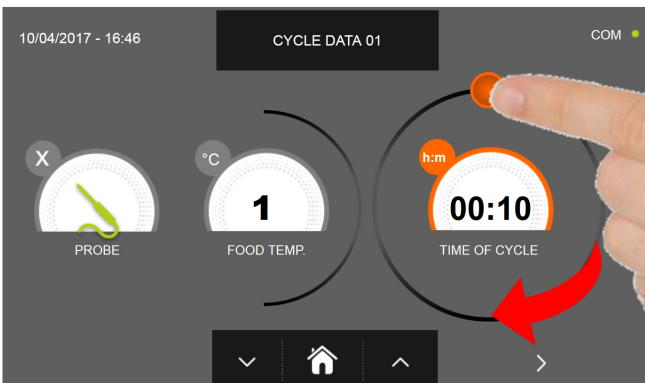

a- Cycle duration setting

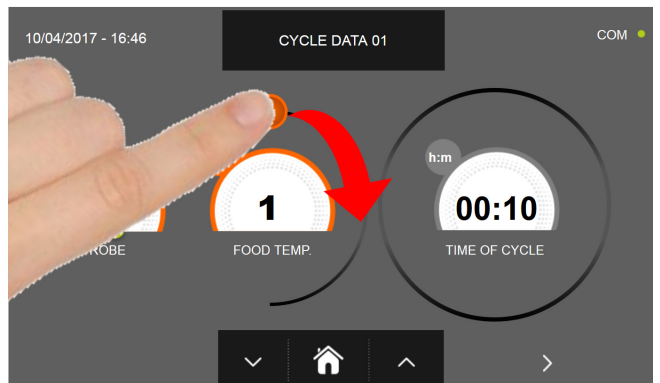

b- Temperature vale setting

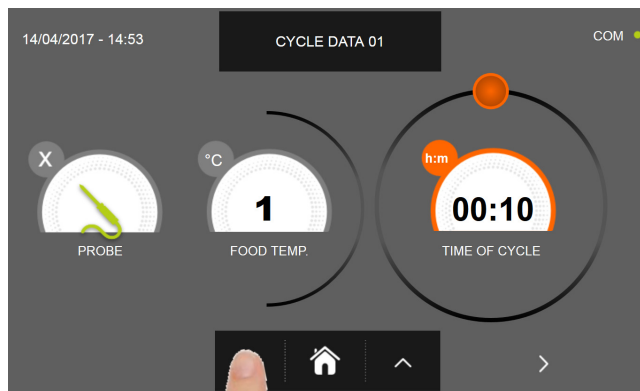



For the food temperature and time values, it is possible to finely set them by using the buttons

- Food temperature setting steps $\pm 1^{\circ}\text{C}$
- Cycle time setting steps ± 10 minuti

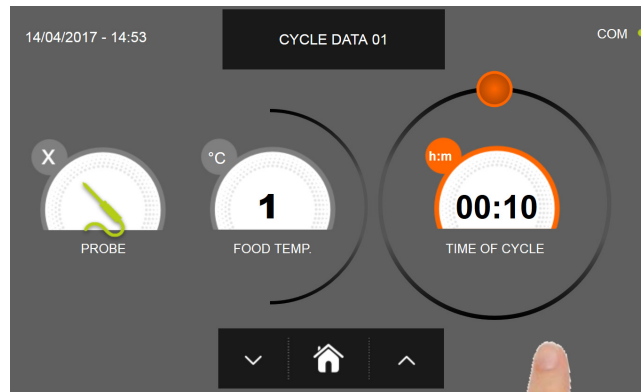
MULTI-PURPOSE BLAST CHILLER EVOLUTION



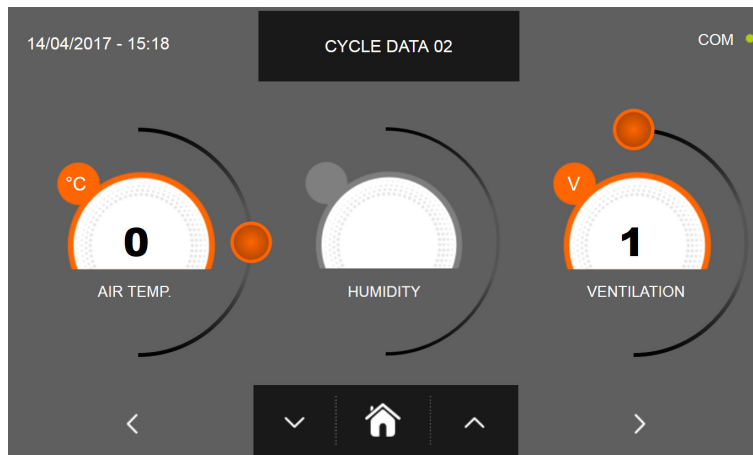

Press the icon  to proceed to the second programming page, press the icon  to go back to the previous page.

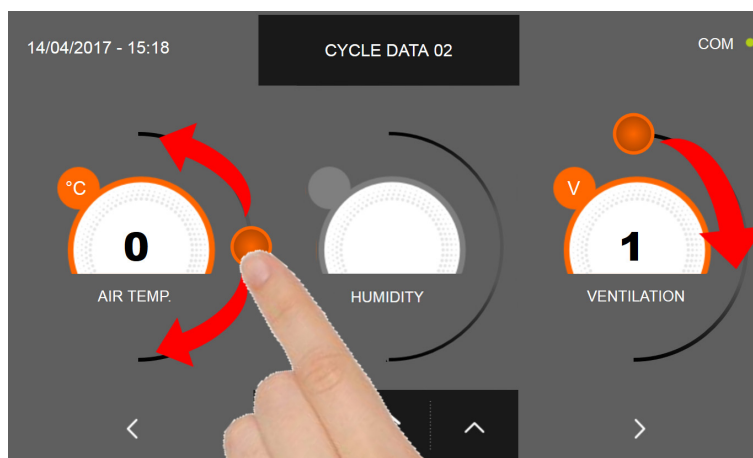

In the second programming page it is possible to set :
 Cell temperature
 Humidity (only for 1HUNDRED and cell temperatures > 0 ° C)
 Ventilation



As per the values set in the first programming page, set the values by moving the cursor as indicated in the picture, or, after selecting the desired field, set the values with the icons  and .

MULTI-PURPOSE BLAST CHILLER EVOLUTION



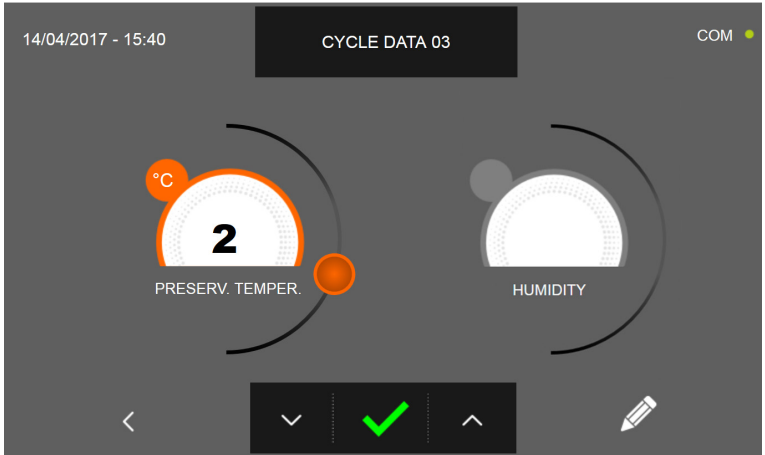

Press the icon  to proceed to the third programming page, press the icon  to go back to the previous page.



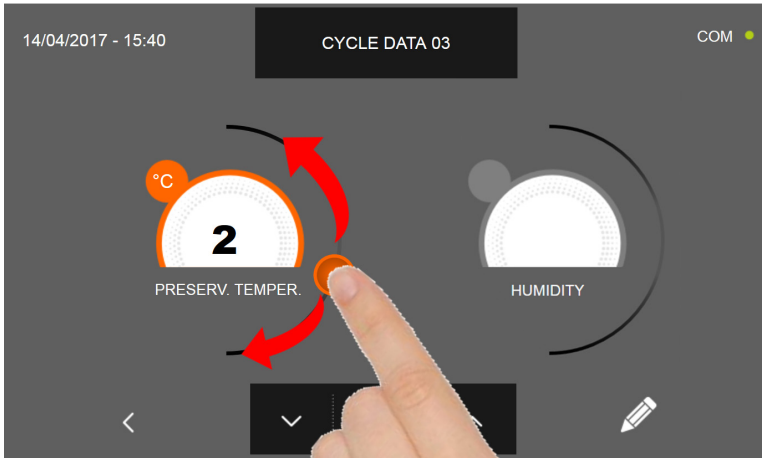

In the third programming page it is possible to set :
Preservation temperature at the end of the cycle
Humidity (only for 1HUNDRED and cell temperatures > 0 ° C)



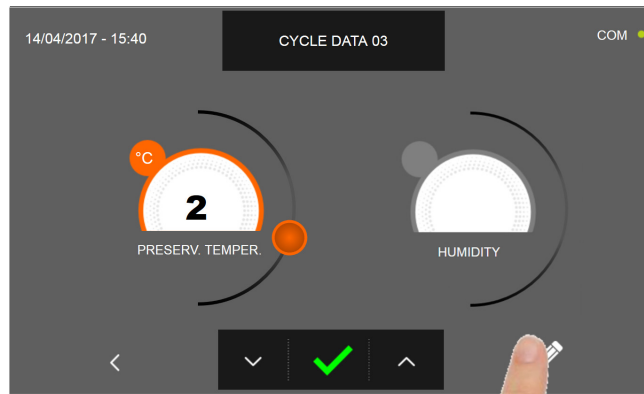

As per the values set in the first programming page, set the values by moving the cursor as indicated in the picture, or, after selecting the desired field, set the values with the icons  and 

MULTI-PURPOSE BLAST CHILLER EVOLUTION

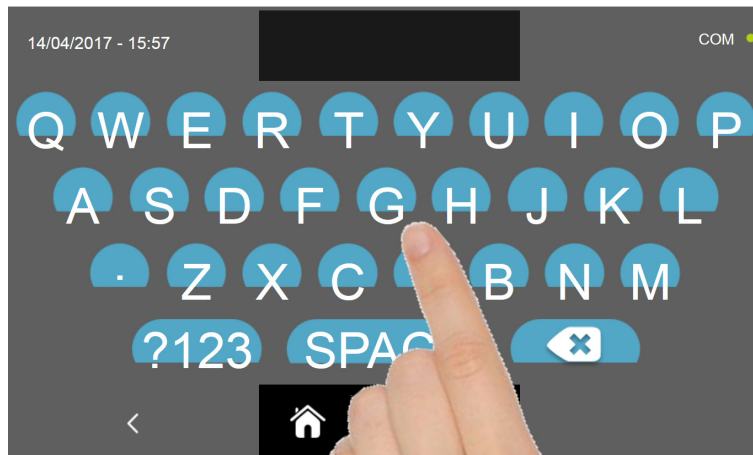

Press the icon  to record the name of a custom cycle and store it for future use.



With the keyboard enter the name of the cycle and then press the icon  to go back to the last programming page.

To delete the cycle just set, before starting the cycle itself, press the icon .

MULTI-PURPOSE BLAST CHILLER EVOLUTION

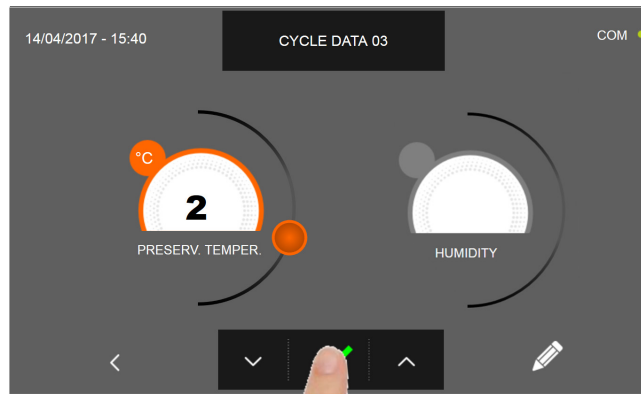

If a custom time cycle was chosen, after pressing the icon  the functioning data screen will be displayed. Refer to paragraph 15 - OPERATION CYCLES to display the temperature chart, input / output, parameter list or multilevel function.

The cycle will end after the set time has elapsed. The end of the cycle is communicated with a buzzer that emits a sound. Press on the display to silence the buzzer. Alternatively, the buzzer automatically mutes after 60 seconds. Once the cycle is finished, the machinery will automatically enter the PRESERVATION mode

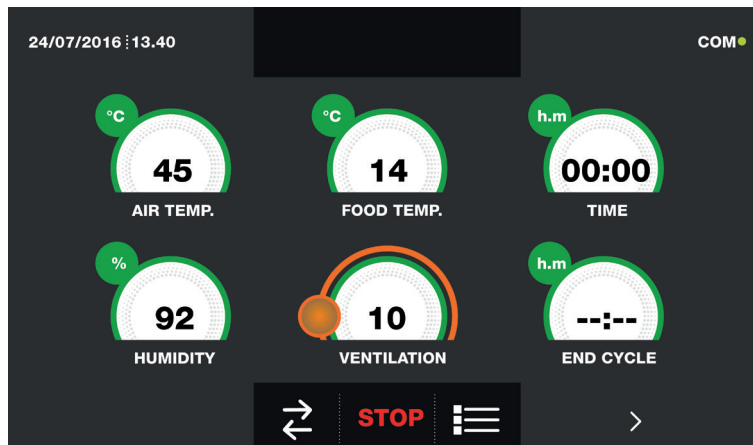

If otherwise the temperature cycle was chosen, after pressing the icon  you will be requested to place the food probe. Refer to paragraph 15 - OPERATION CYCLES to display the temperature chart, input / output, parameter list or multilevel function.

During the cycle, by moving the cursor as shown in the figure, the ventilation value can be varied, with set 1 ÷ 10:

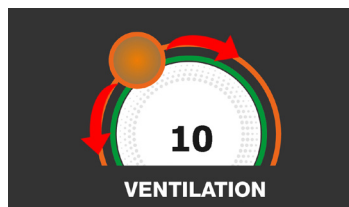

Once you have placed the food probe and after the machinery has correctly sensed the probe positioning, the cycle will start and the functioning screen will be displayed. The cycle will finish when the temperature at the core of the product will be lower or equal to the temperature set. The end of the cycle will be communicated with a buzzer that emits a sound. Press on the display to silence the buzzer. Alternatively, the buzzer automatically mutes after 60 seconds. Once the cycle is finished, the machinery will automatically enter the PRESERVATION mode.

We remind you that this phase can be maintained for a maximum recommended period of 24 hours.

16.6 - MANUAL BLAST CHILLING CYCLE

The BLAST CHILLING cycle is used to rapidly cool foods obtaining a final positive product's core temperature.

With the machinery in STAND-BY mode, press the power icon as described in chapter 16.1. Once you have access to the HOME PAGE, proceed as follows:

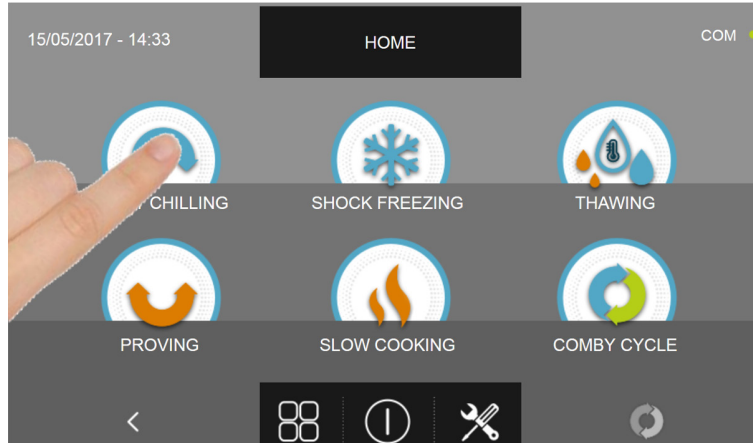

Press the BLAST CHILLING icon to access its selection menu

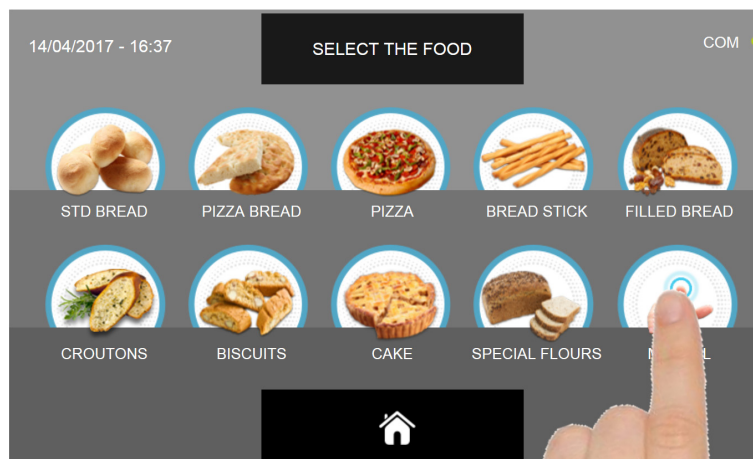

Select the icon MANUAL

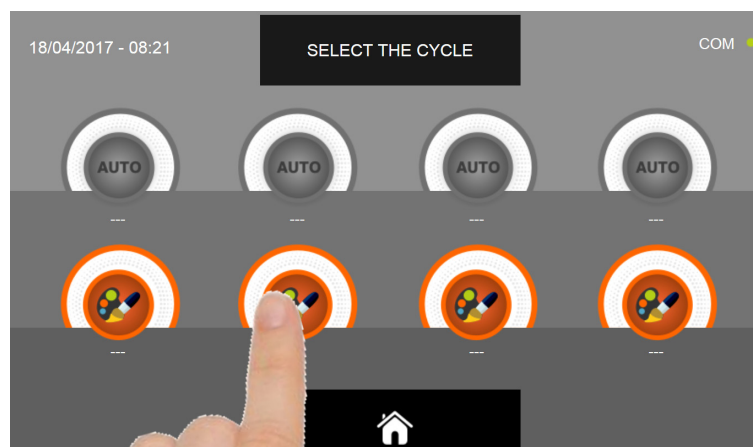

Select the setting icon of a CUSTOM cycle

N.B. THE AUTOMATIC CYCLES ARE NOT AVAILABLE

MULTI-PURPOSE BLAST CHILLER EVOLUTION

There are two type of MANUAL cycles :

a- Time manual cycle (Preferred choice)

b- Manual cycle with temperature probe

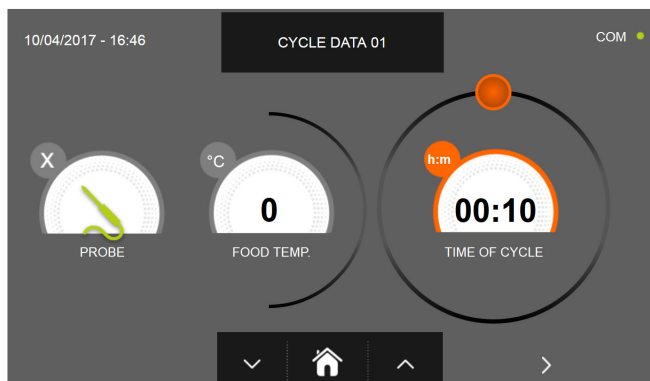

a- Time manual cycle

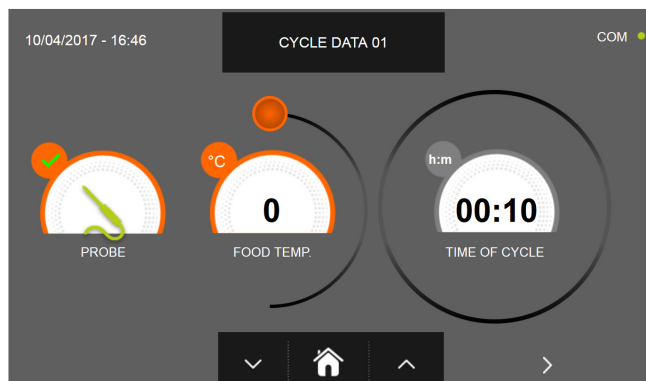

b- Manual cycle with temperature probe

N.B. To select the temperature probe cycle press the PROBE icon, to return to the time selection press the PROBE icon again.

To set the Time or Temperature values, move the cursor as shown in the following pictures :

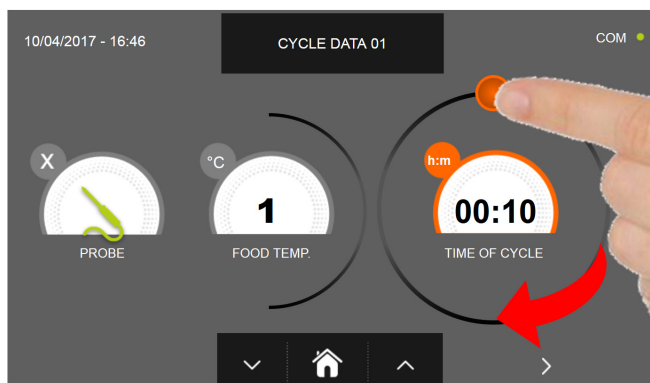

a- Cycle duration setting



b- Temperature vale setting



For the food temperature and time values, it is possible to finely set them by using the buttons





and

- Food temperature setting steps $\pm 1^{\circ}\text{C}$
- Cycle time setting steps ± 10 minuti

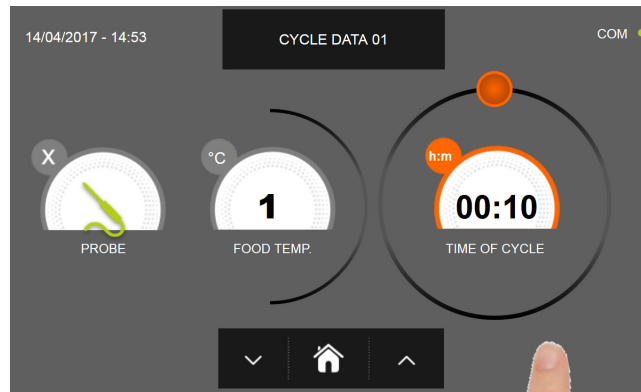
MULTI-PURPOSE BLAST CHILLER EVOLUTION



Press the icon  to proceed to the second programming page, press the icon  to go back to the previous page

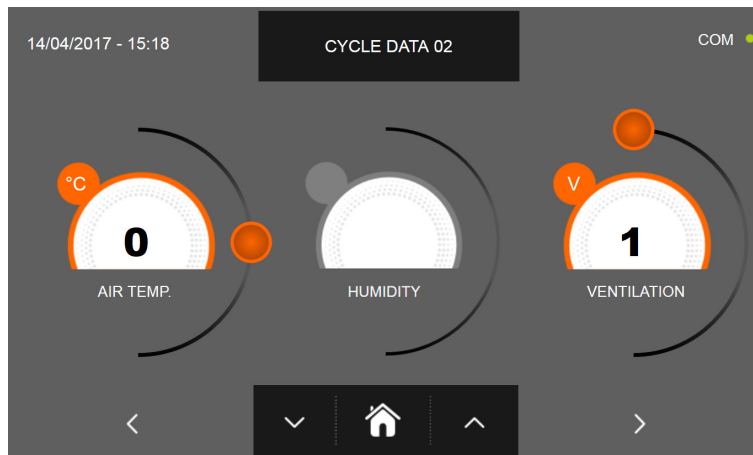

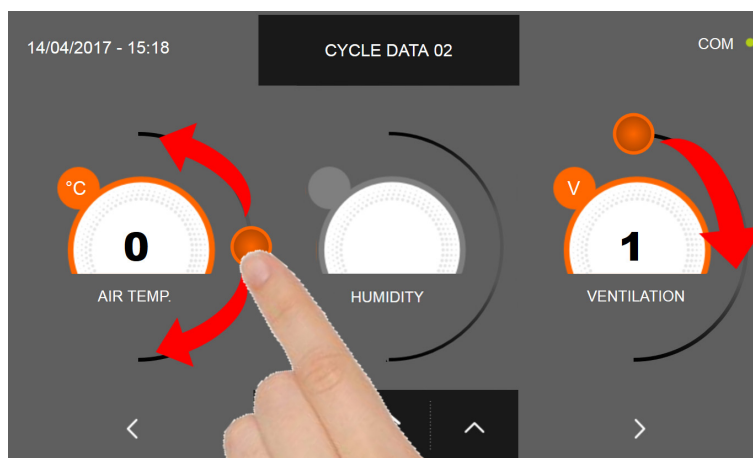

In the second programming page it is possible to set :

- Cell temperature
- Humidity (only for 1HUNDRED and cell temperatures > 0 ° C)
- Ventilation





As per the values set in the first programming page, set the values by moving the cursor as indicated in the picture, or,

after selecting the desired field, set the values with the icons  and 

MULTI-PURPOSE BLAST CHILLER EVOLUTION



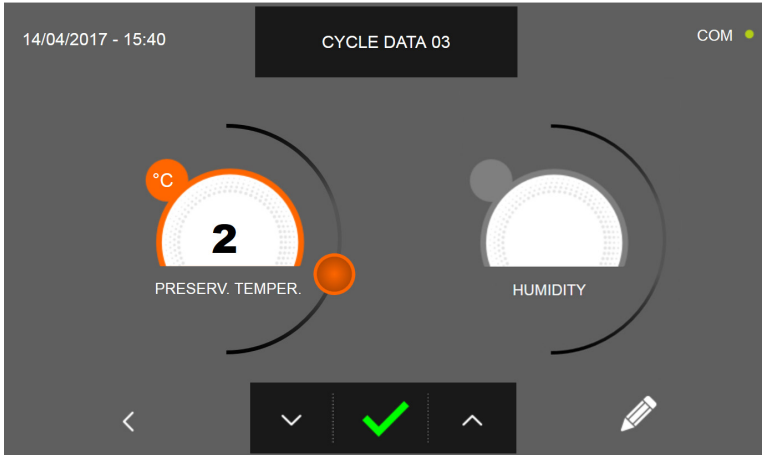

Press the icon  to proceed to the third programming page, press the icon  to go back to the previous page.



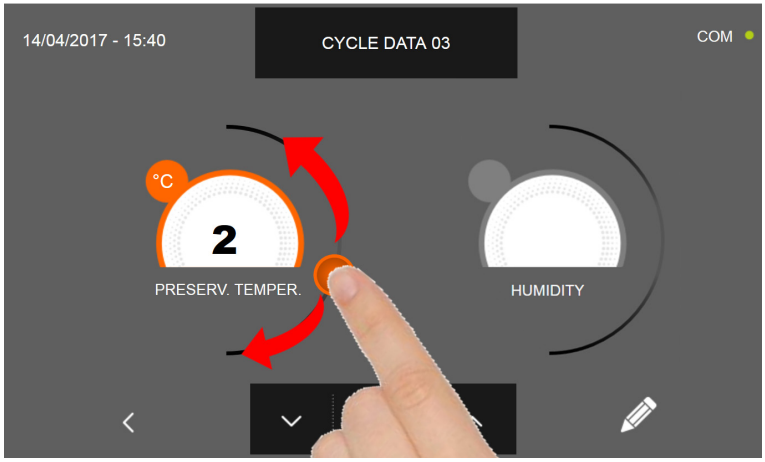

In the third programming page it is possible to set :
 Preservation temperature at the end of the cycle
 Humidity (only for 1HUNDRED and cell temperatures > 0 ° C)



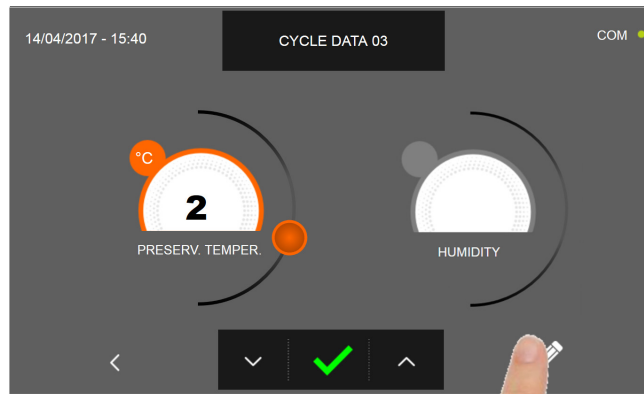

As per the values set in the first programming page, set the values by moving the cursor as indicated in the picture, or, after selecting the desired field, set the values with the icons  and 

MULTI-PURPOSE BLAST CHILLER EVOLUTION

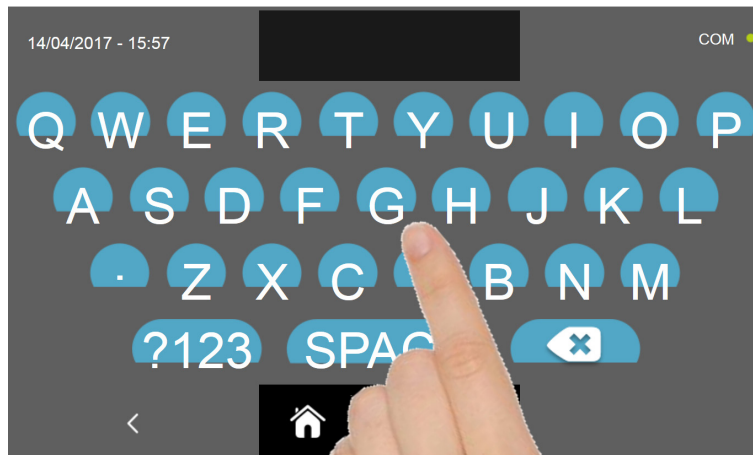

Press the icon  to record the name of a custom cycle and store it for future use.



With the keyboard enter the name of the cycle and then press the icon  to go back to the last programming page.

To delete the cycle just set, before starting the cycle itself, press the icon .

MULTI-PURPOSE BLAST CHILLER EVOLUTION

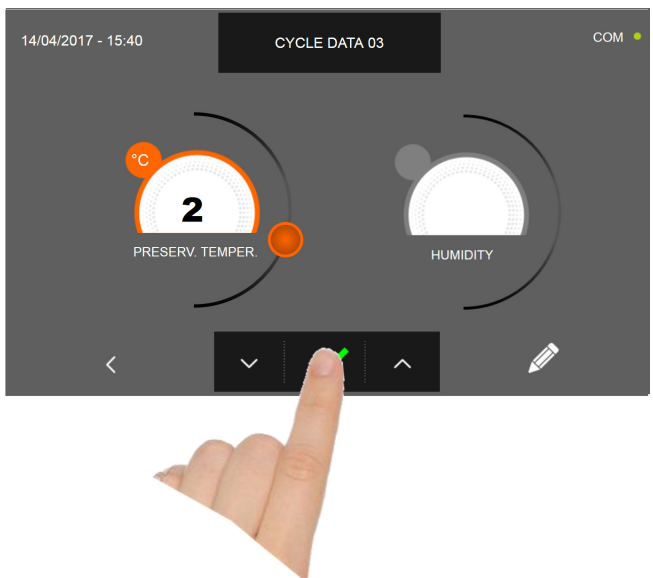

If a manual time cycle was chosen, after pressing the icon  the functioning data screen will be displayed. Refer to paragraph 15 - OPERATION CYCLES to display the temperature chart, input / output, parameter list or multilevel function. The cycle will end after the set time has elapsed. The end of the cycle is communicated with a buzzer that emits a sound. Press on the display to silence the buzzer. Alternatively, the buzzer automatically mutes after 60 seconds. Once the cycle is finished, the machinery will automatically enter the PRESERVATION mode

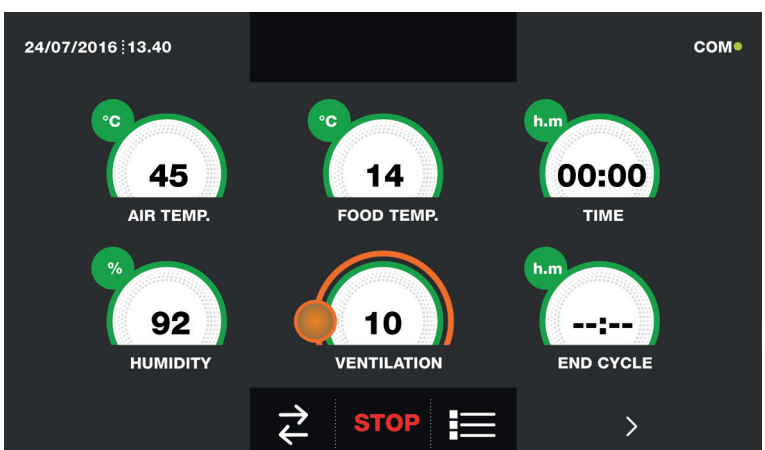

If otherwise the manual temperature cycle was chosen, after pressing the icon  you will be requested to place the food probe. Refer to paragraph 15 - OPERATION CYCLES to display the temperature chart, input / output, parameter list or multilevel function. During the cycle, by moving the cursor as shown in the figure, the ventilation value can be varied, with set 1 ÷ 10:

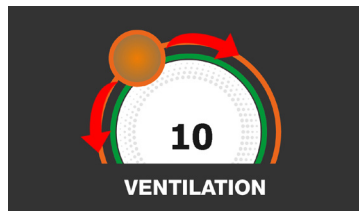

Once you have placed the food probe and after the machinery has correctly sensed the probe positioning, the cycle will start and the functioning screen will be displayed. The cycle will finish when the temperature at the core of the product will be lower or equal to the temperature set. The end of the cycle will be communicated with a buzzer that emits a sound. Press on the display to silence the buzzer. Alternatively, the buzzer automatically mutes after 60 seconds. Once the cycle is finished, the machinery will automatically enter the PRESERVATION mode.

We remind you that this phase can be maintained for a maximum recommended period of 24 hours.

16.7 - AUTOMATIC SHOCK FREEZING CYCLE

The SHOCK FREEZING cycle is used to cool foods obtaining a final negative product's core temperature.

With the machinery in STAND-BY mode, press the power icon as described in chapter 16.1. Once you have access to the HOME PAGE, proceed as follows:

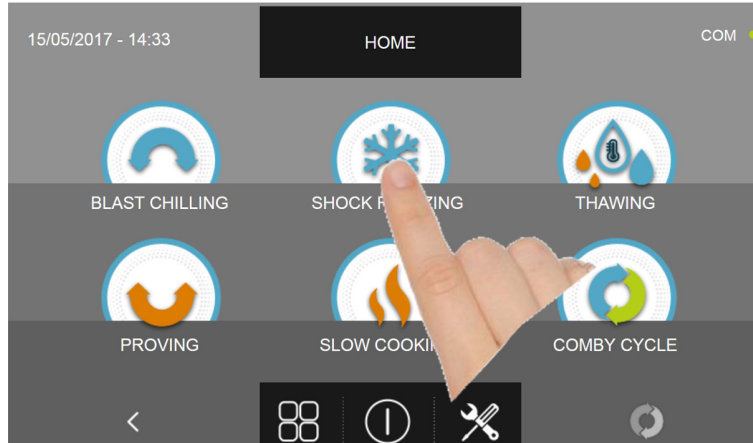

Press the icon SHOCK FREEZING to access its selection menu

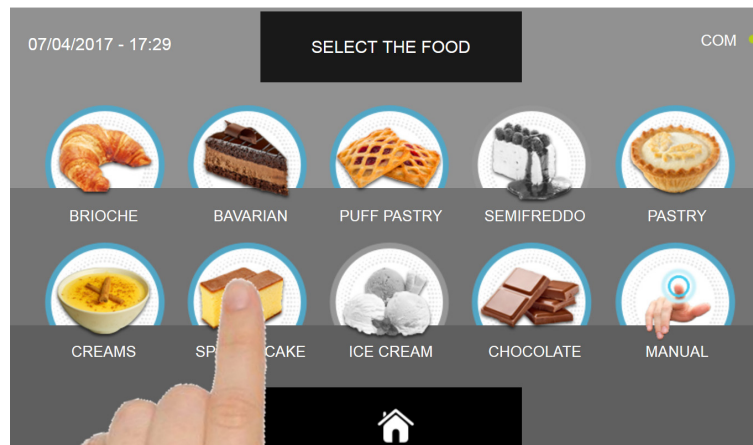

Select one of the food categories in the menu.

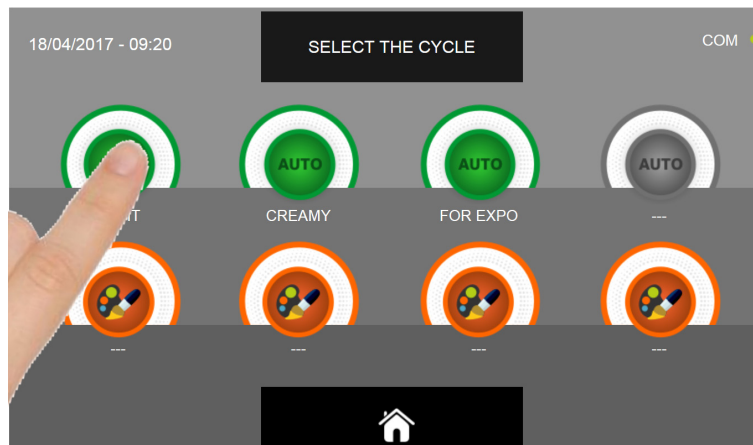

Select the green icon (AUTO) specific for the selected food.

MULTI-PURPOSE BLAST CHILLER EVOLUTION

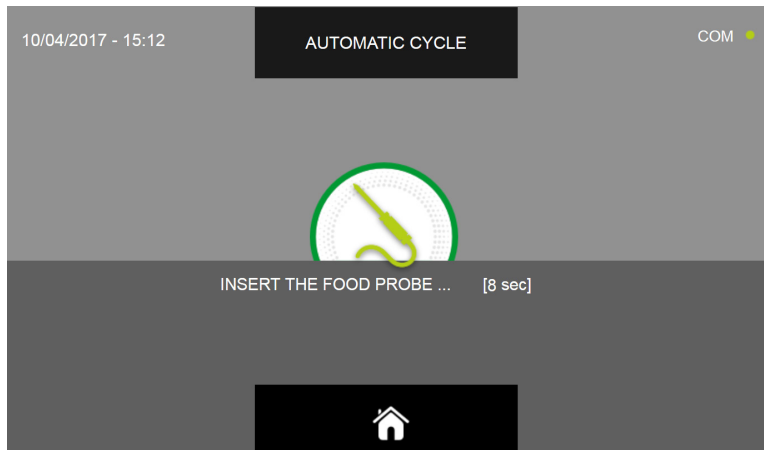

Once you have selected the type of food, you will be asked to place the food core probe. The cycle will automatically start after the probe is detected.

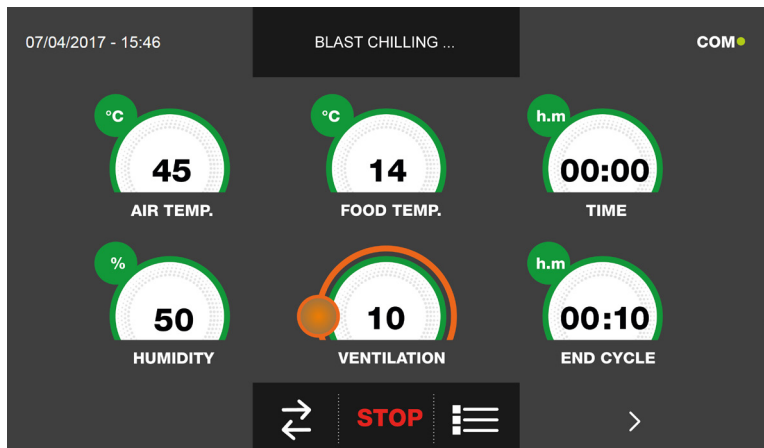

When the cycle is active, the screen with the operating data is displayed. Refer to paragraph 15 - OPERATION CYCLES to display the temperature chart, input / output, parameter list or multilevel function.

During the cycle, by moving the cursor as shown in the figure, the ventilation value can be varied, with set 1 ÷ 10 :



The cycle will finish when the temperature at the core of the product will be lower or equal to the pre-set temperature. The end of the cycle will be communicated with a buzzer that emits a sound. Press on the display to silence the buzzer. Alternatively, the buzzer automatically mutes after 60 seconds. Once the cycle is finished, the machinery will automatically enter the PRESERVATION mode.

We remind you that this phase can be maintained for a maximum recommended period of 24 hours.

16.8 - CUSTOM SHOCK FREEZING CYCLE

The SHOCK FREEZING cycle is used to cool foods obtaining a final negative product's core temperature.

With the machinery in STAND-BY mode, press the power icon as described in chapter 16.1. Once you have access to the HOME PAGE, proceed as follows:

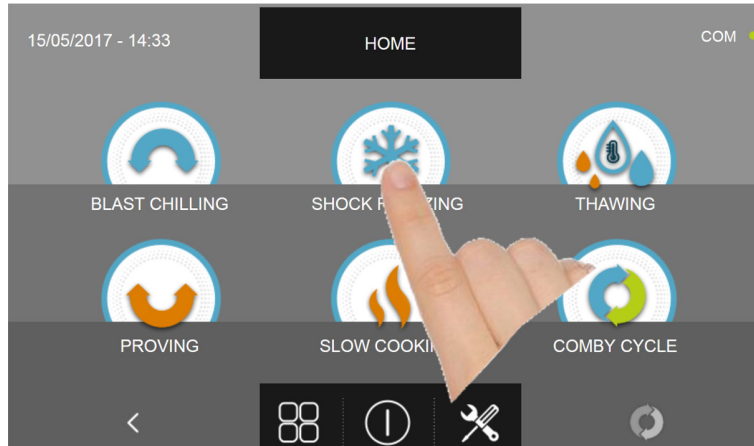

Press the icon SHOCK FREEZING to access its selection menu

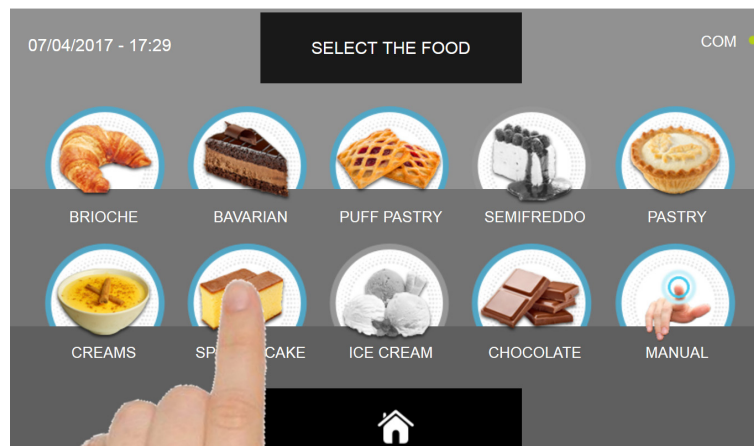

Select one of the food categories in the menu.

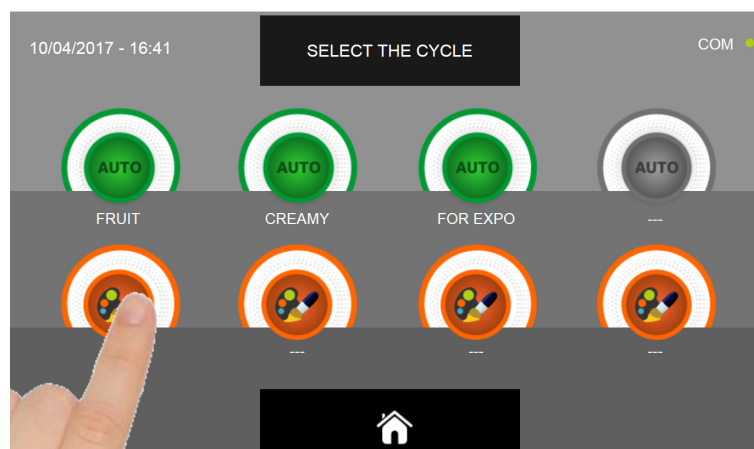

Select the setting icon of a CUSTOM cycle

MULTI-PURPOSE BLAST CHILLER EVOLUTION

There are two type of CUSTOM cycles :

- a- Time custom cycle (Preferred choice)
- b- Custom cycle with temperature probe

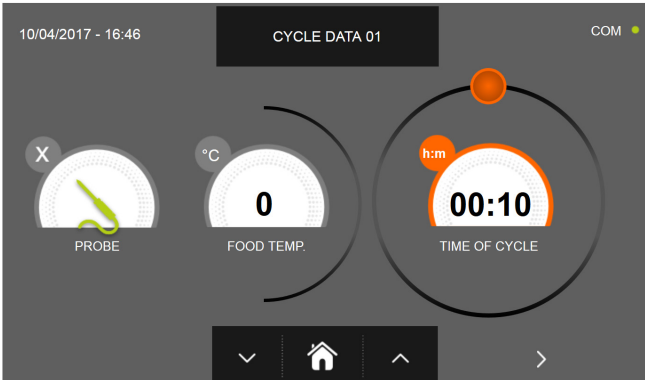

a- Time custom cycle

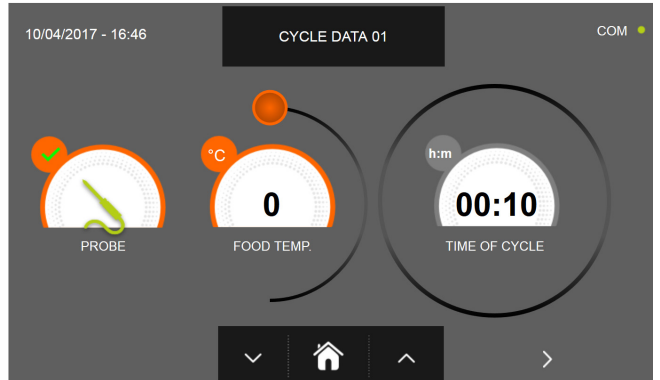

b- Custom cycle with temperature probe

N.B. To select the temperature probe cycle press the PROBE icon, to return to the time selection press the PROBE icon again.

To set the Time or Temperature values, move the cursor as shown in the following pictures :

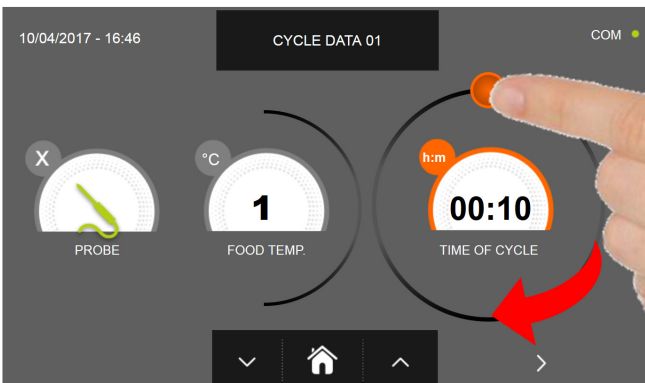

a- Cycle duration setting

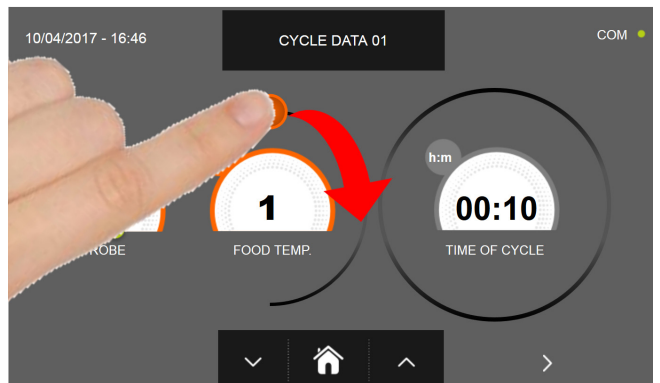

b- Temperature vale setting

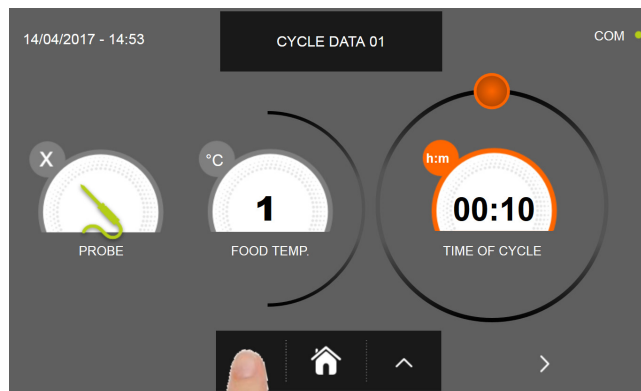

For the food temperature and time values, it is possible to finely set them by using the buttons





and

- Food temperature setting steps $\pm 1^{\circ}\text{C}$
- Cycle time setting steps ± 10 minuti

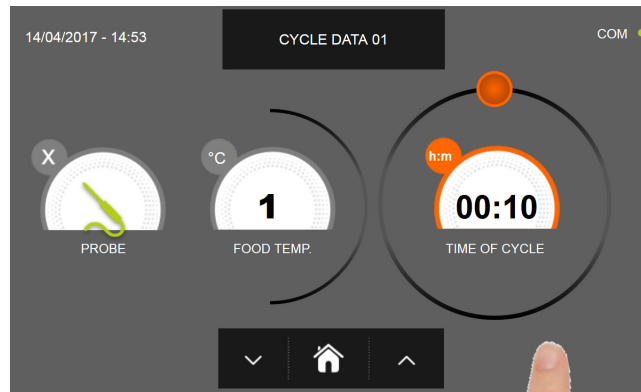
MULTI-PURPOSE BLAST CHILLER EVOLUTION



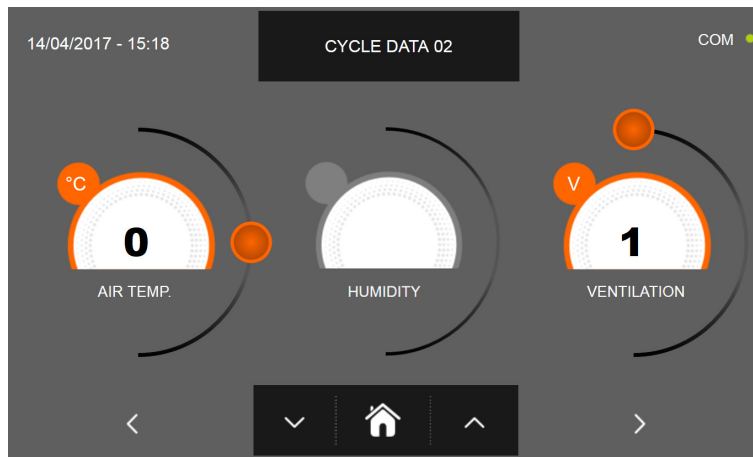

Press the icon  to proceed to the second programming page, press the icon  to go back to the previous page.

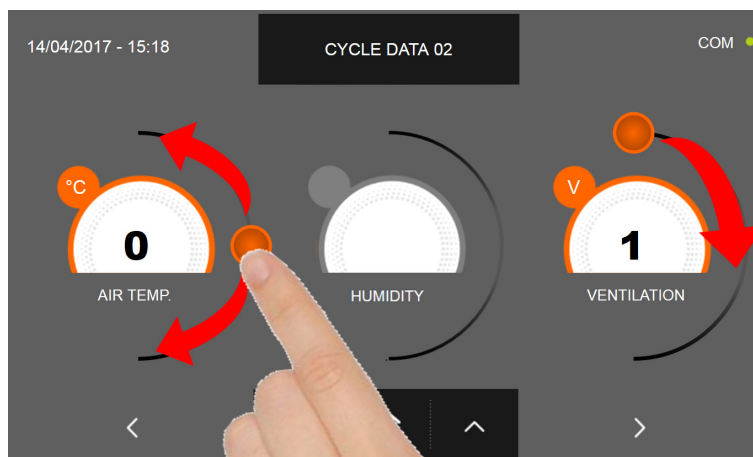

In the second programming page it is possible to set :
Cell temperature
Ventilation





As per the values set in the first programming page, set the values by moving the cursor as indicated in the picture, or,

after selecting the desired field, set the values with the icons  and 

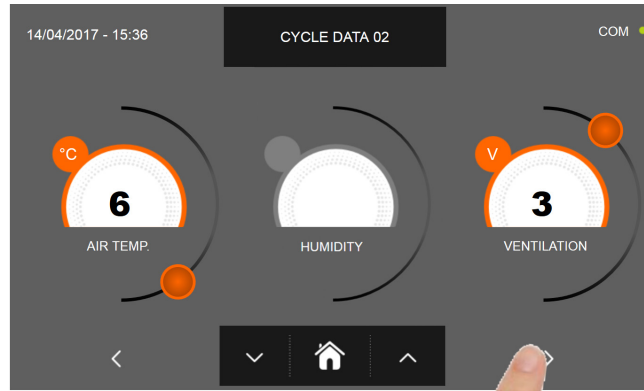
MULTI-PURPOSE BLAST CHILLER EVOLUTION



Press the icon  to proceed to the third programming page, press the icon  to go back to the previous page.

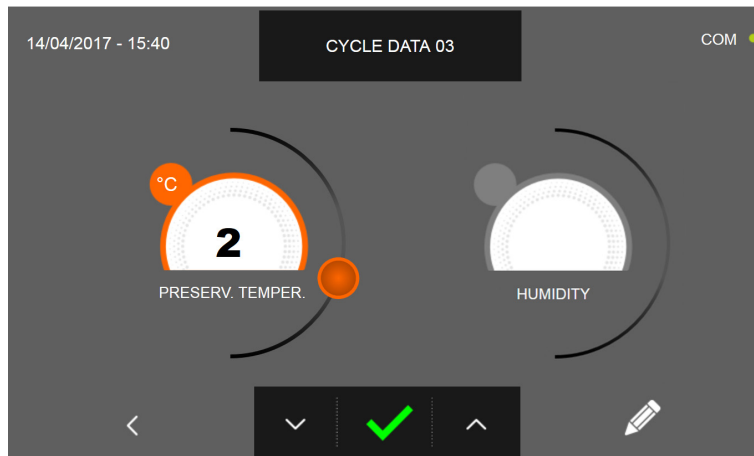

In the third programming page it is possible to set :
Preservation temperature at the end of the cycle





As per the values set in the first programming page, set the values by moving the cursor as indicated in the picture, or,

after selecting the desired field, set the values with the icons



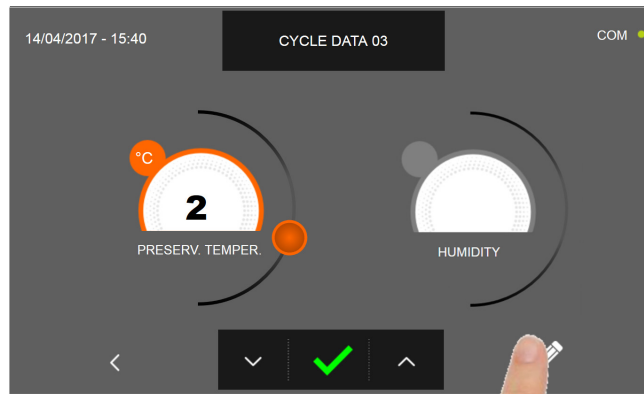

MULTI-PURPOSE BLAST CHILLER EVOLUTION

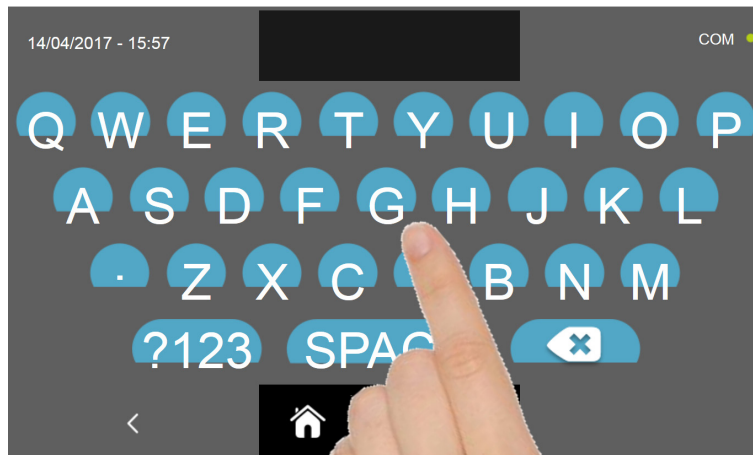

Press the icon  to record the name of a custom cycle and store it for future use.



With the keyboard enter the name of the cycle and then press the icon  to go back to the last programming page.

To delete the cycle just set, before starting the cycle itself, press the icon .

MULTI-PURPOSE BLAST CHILLER EVOLUTION

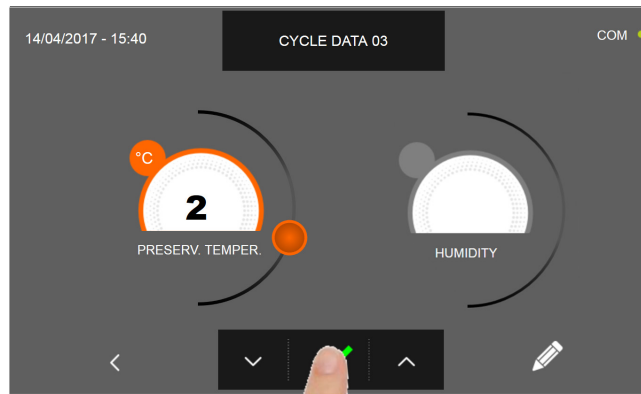

If a custom time cycle was chosen, after pressing the icon  the functioning data screen will be displayed. Refer to paragraph 15 - OPERATION CYCLES to display the temperature chart, input / output, parameter list or multilevel function.

The cycle will end after the set time has elapsed. The end of the cycle is communicated with a buzzer that emits a sound. Press on the display to silence the buzzer. Alternatively, the buzzer automatically mutes after 60 seconds. Once the cycle is finished, the machinery will automatically enter the PRESERVATION mode

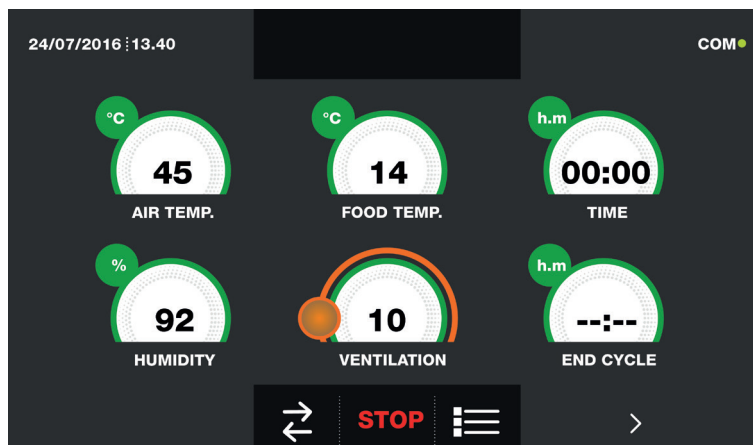

If otherwise the temperature cycle was chosen, after pressing the icon  you will be requested to place the food probe. Refer to paragraph 15 - OPERATION CYCLES to display the temperature chart, input / output, parameter list or multilevel function.

During the cycle, by moving the cursor as shown in the figure, the ventilation value can be varied, with set 1 ÷ 10:

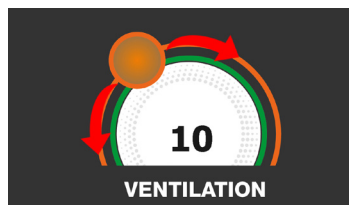

Once you have placed the food probe and after the machinery has correctly sensed the probe positioning, the cycle will start and the functioning screen will be displayed. The cycle will finish when the temperature at the core of the product will be lower or equal to the temperature set. The end of the cycle will be communicated with a buzzer that emits a sound. Press on the display to silence the buzzer. Alternatively, the buzzer automatically mutes after 60 seconds. Once the cycle is finished, the machinery will automatically enter the PRESERVATION mode.

We remind you that this phase can be maintained for a maximum recommended period of 24 hours.

16.9 - MANUAL SHOCK FREEZING CYCLE

The SHOCK FREEZING cycle is used to cool foods obtaining a final negative product's core temperature.

With the machinery in STAND-BY mode, press the power icon as described in chapter 16.1. Once you have access to the HOME PAGE, proceed as follows:

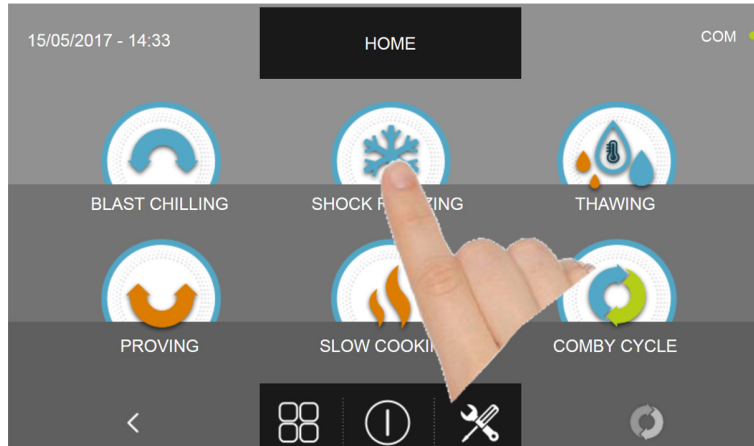

Press the icon SHOCK FREEZING to access its selection menu

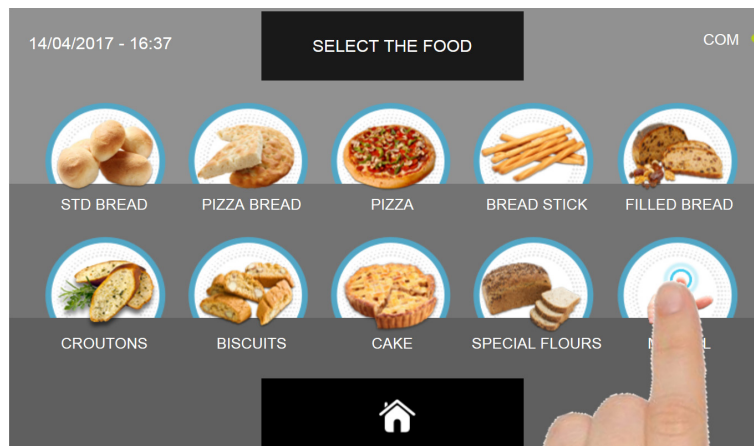

Select the icon MANUAL

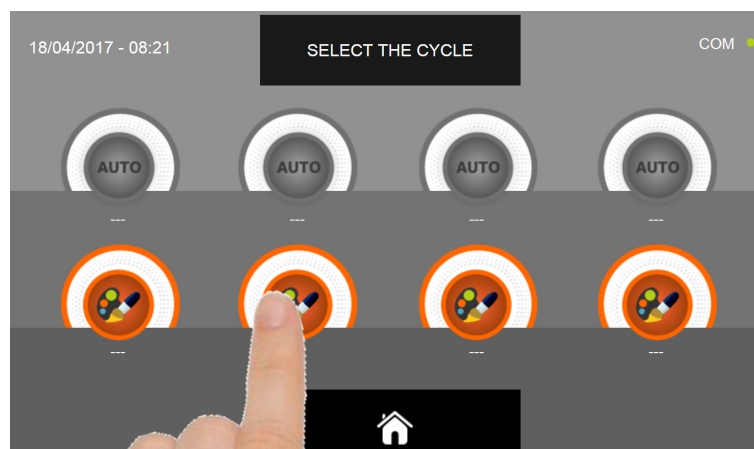

Select the setting icon of a CUSTOM cycle

N.B. THE AUTOMATIC CYCLES ARE NOT AVAILABLE

MULTI-PURPOSE BLAST CHILLER EVOLUTION

There are two type of MANUAL cycles :

- a- Time manual cycle (Preferred choice)
- b- Manual cycle with temperature probe

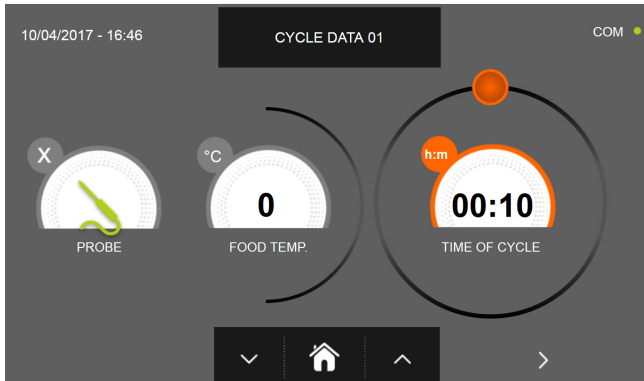

a- Time manual cycle

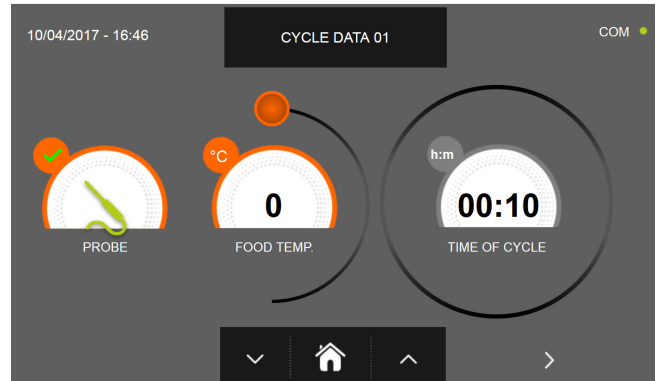

b- Manual cycle with temperature probe

N.B. To select the temperature probe cycle press the PROBE icon, to return to the time selection press the PROBE icon again.

To set the Time or Temperature values, move the cursor as shown in the following pictures :

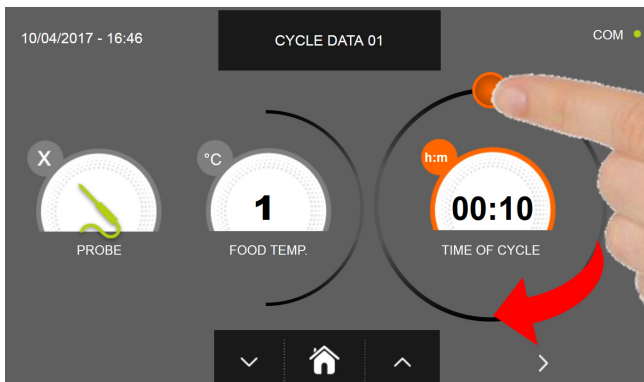

a- Cycle duration setting

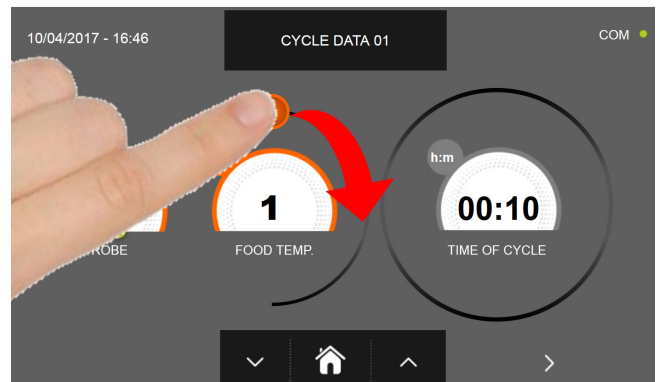

b- Temperature vale setting





For the food temperature and time values, it is possible to finely set them by using the buttons

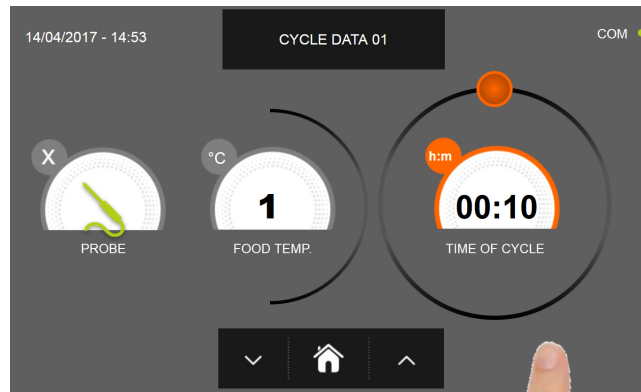

- Food temperature setting steps $\pm 1^{\circ}\text{C}$
- Cycle time setting steps ± 10 minuti

MULTI-PURPOSE BLAST CHILLER EVOLUTION



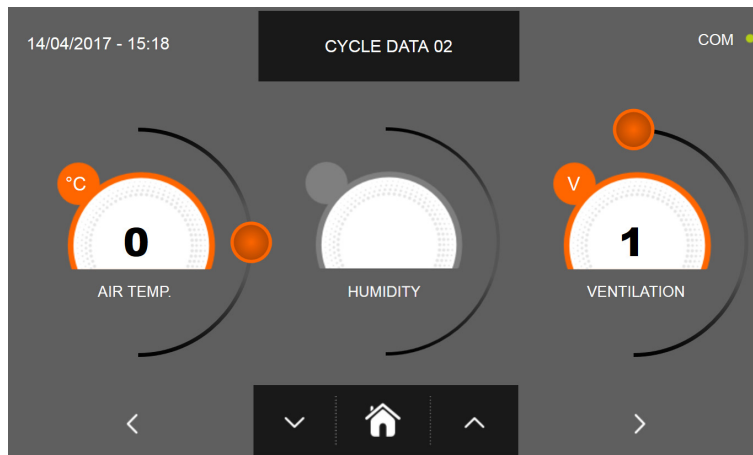

Press the icon  to proceed to the second programming page, press the icon  to go back to the previous page

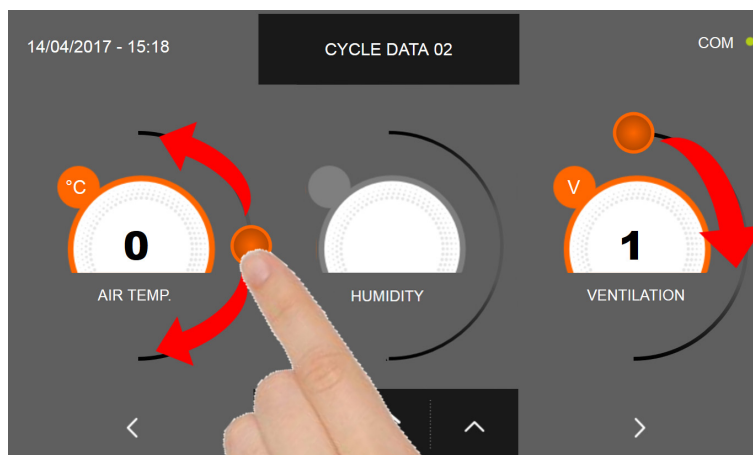

In the second programming page it is possible to set :
Cell temperature
Ventilation





As per the values set in the first programming page, set the values by moving the cursor as indicated in the picture, or,

after selecting the desired field, set the values with the icons  and 

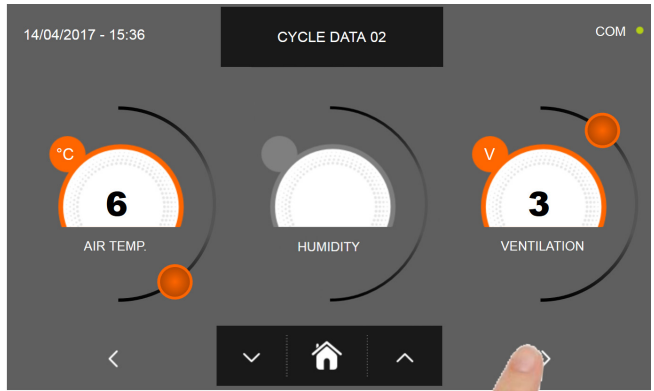
MULTI-PURPOSE BLAST CHILLER EVOLUTION



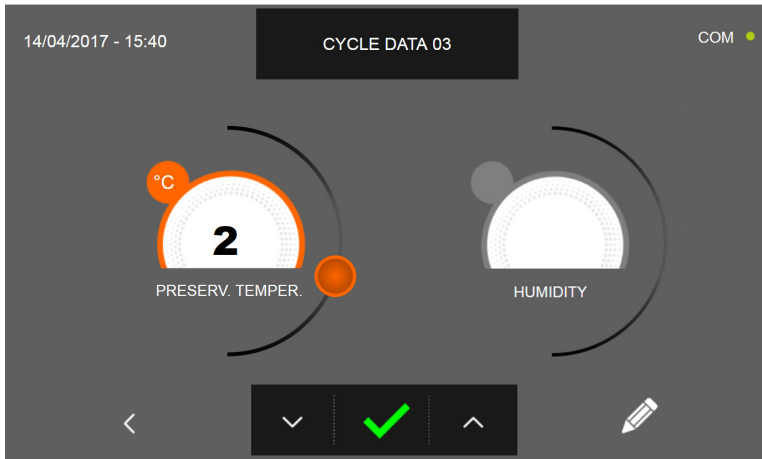

Press the icon  to proceed to the third programming page, press the icon  to go back to the previous page.





In the third programming page it is possible to set :
Preservation temperature at the end of the cycle



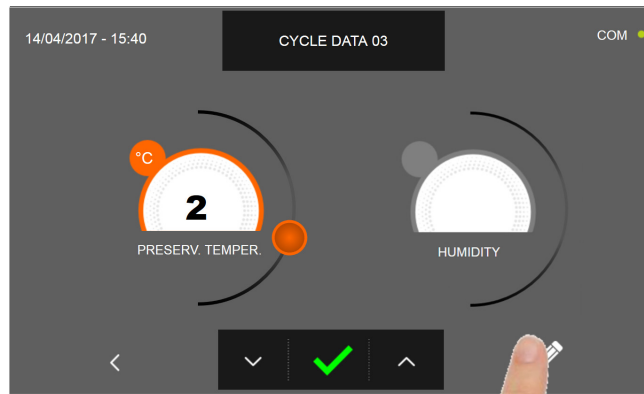

As per the values set in the first programming page, set the values by moving the cursor as indicated in the picture, or,
after selecting the desired field, set the values with the icons  and 

MULTI-PURPOSE BLAST CHILLER EVOLUTION

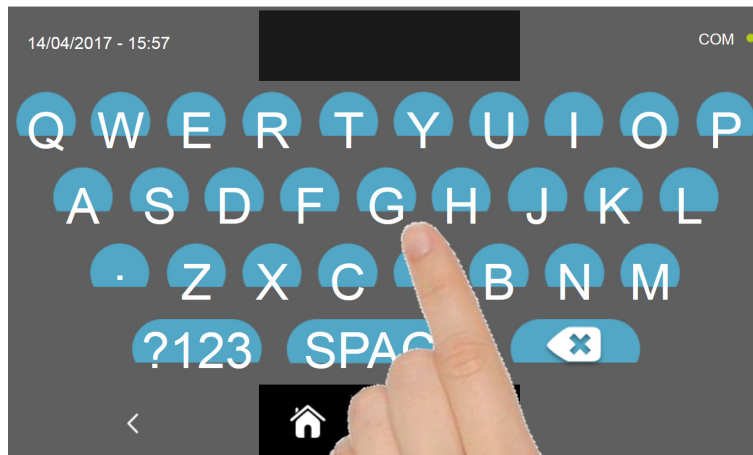

Press the icon  to record the name of a custom cycle and store it for future use.



With the keyboard enter the name of the cycle and then press the icon  to go back to the last programming page.

To delete the cycle just set, before starting the cycle itself, press the icon .

MULTI-PURPOSE BLAST CHILLER EVOLUTION

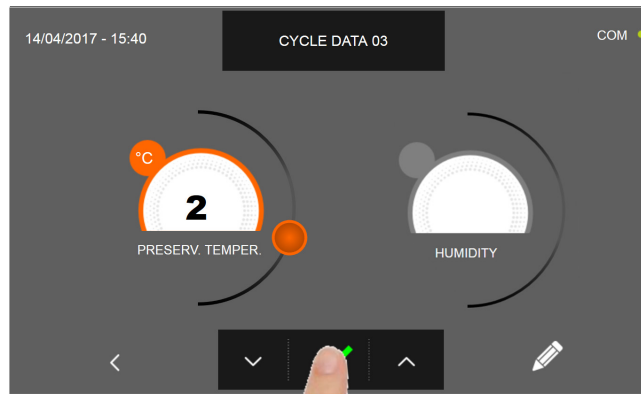

If a manual time cycle was chosen, after pressing the icon  the functioning data screen will be displayed. Refer to paragraph 15 - OPERATION CYCLES to display the temperature chart, input / output, parameter list or multilevel function.

The cycle will end after the set time has elapsed. The end of the cycle is communicated with a buzzer that emits a sound. Press on the display to silence the buzzer. Alternatively, the buzzer automatically mutes after 60 seconds. Once the cycle is finished, the machinery will automatically enter the PRESERVATION mode

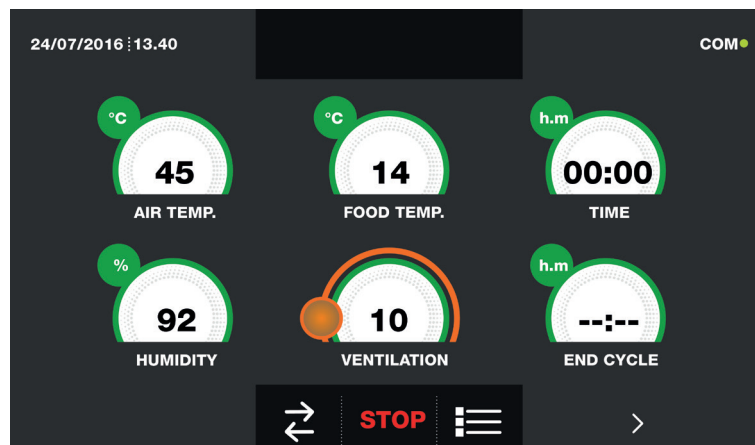

If otherwise the manual temperature cycle was chosen, after pressing the icon  you will be requested to place the food probe. Refer to paragraph 15 - OPERATION CYCLES to display the temperature chart, input / output, parameter list or multilevel function.

During the cycle, by moving the cursor as shown in the figure, the ventilation value can be varied, with set 1 ÷ 10:

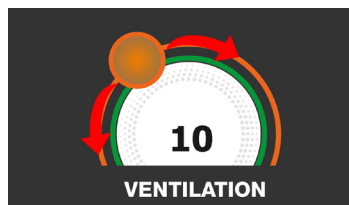

Once you have placed the food probe and after the machinery has correctly sensed the probe positioning, the cycle will start and the functioning screen will be displayed. The cycle will finish when the temperature at the core of the product will be lower or equal to the temperature set. The end of the cycle will be communicated with a buzzer that emits a sound. Press on the display to silence the buzzer. Alternatively, the buzzer automatically mutes after 60 seconds. Once the cycle is finished, the machinery will automatically enter the PRESERVATION mode.

We remind you that this phase can be maintained for a maximum recommended period of 24 hours.

16.10 - AUTOMATIC THAWING CYCLE

The THAWING cycle is used to raise the temperature of food from a negative to a positive value.

With the machinery in STAND-BY mode, press the power icon as described in chapter 16.1. Once you have access to the HOME PAGE, proceed as follows:

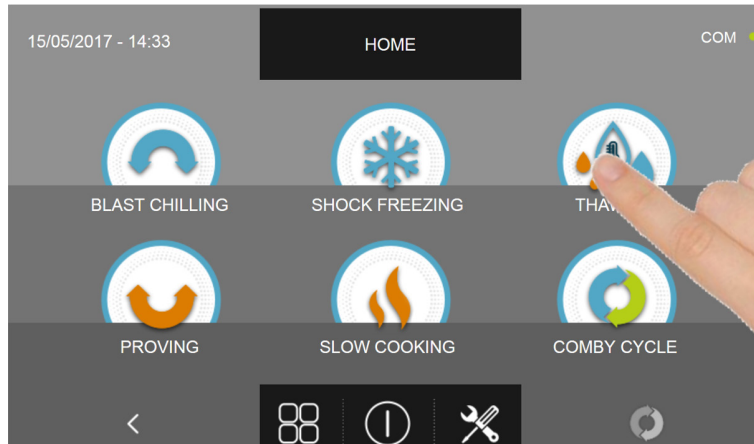

Press the THAWING icon to access its selection menu

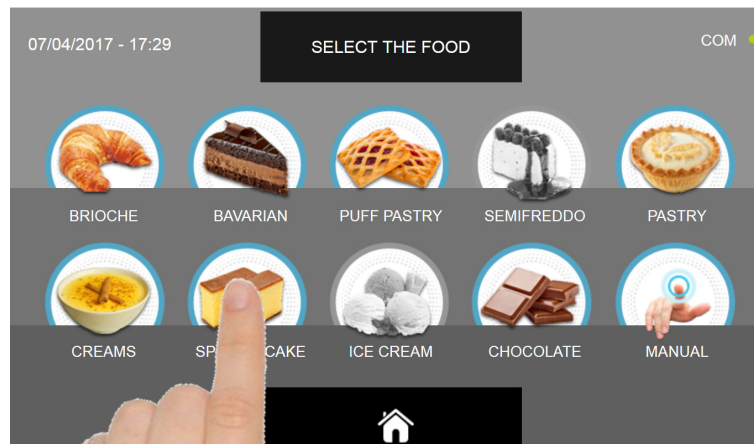

Select one of the food categories in the menu.

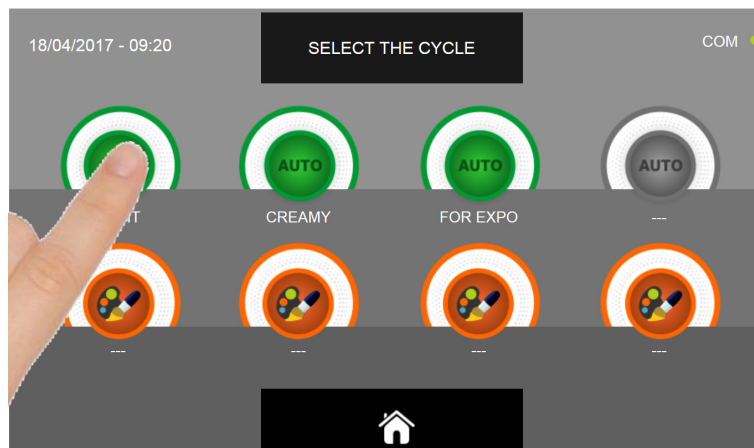

Select the green icon (AUTO) specific for the selected food.

MULTI-PURPOSE BLAST CHILLER EVOLUTION

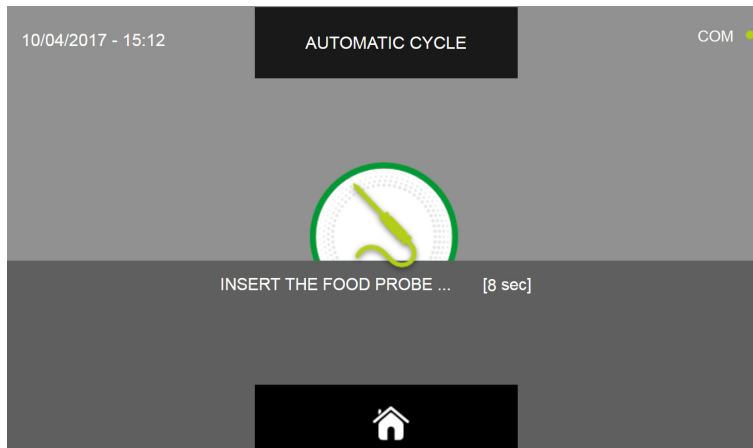

Once you have selected the type of food, you will be asked to place the food core probe. The cycle will automatically start after the probe is detected.

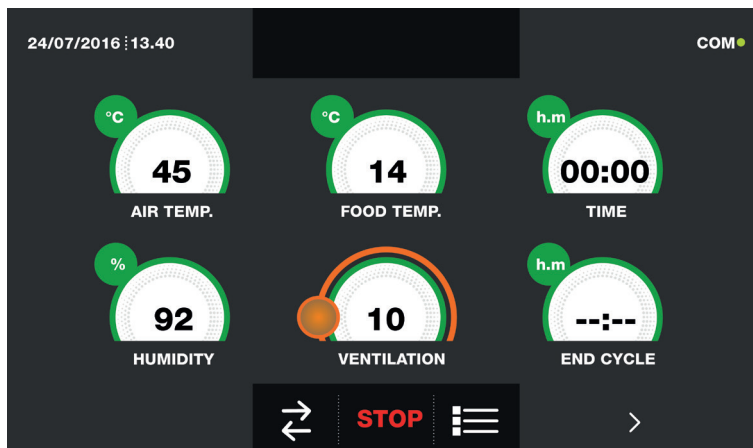

When the cycle is active, the screen with the operating data is displayed. Refer to paragraph 15 - OPERATION CYCLES to display the temperature chart, input / output, parameter list or multilevel function.

During the cycle, by moving the cursor as shown in the figure, the ventilation value can be varied, with set 1 ÷ 10 :

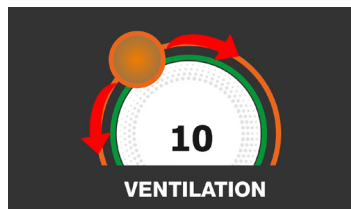

The cycle will finish when the temperature at the core of the product will be lower or equal to the pre-set temperature. The end of the cycle will be communicated with a buzzer that emits a sound. Press on the display to silence the buzzer. Alternatively, the buzzer automatically mutes after 60 seconds. Once the cycle is finished, the machinery will automatically enter the PRESERVATION mode.

We remind you that this phase can be maintained for a maximum recommended period of 24 hours.

16.11 - CUSTOM THAWING CYCLE

The THAWING cycle is used to raise the temperature of food from a negative to a positive value.

With the machinery in STAND-BY mode, press the power icon as described in chapter 16.1. Once you have access to the HOME PAGE, proceed as follows:

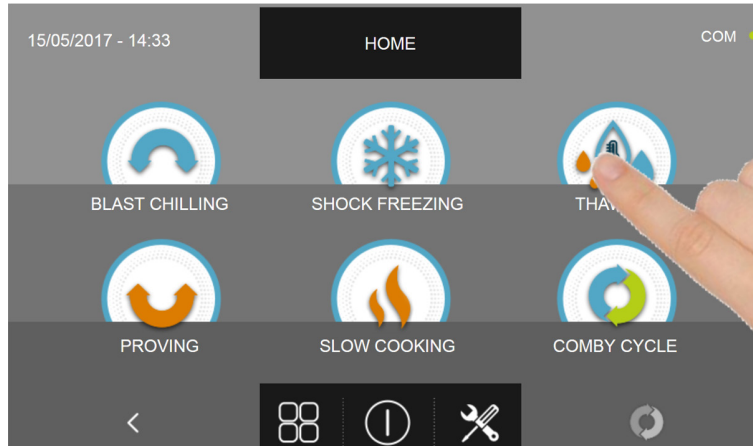

Press the THAWING icon to access its selection menu

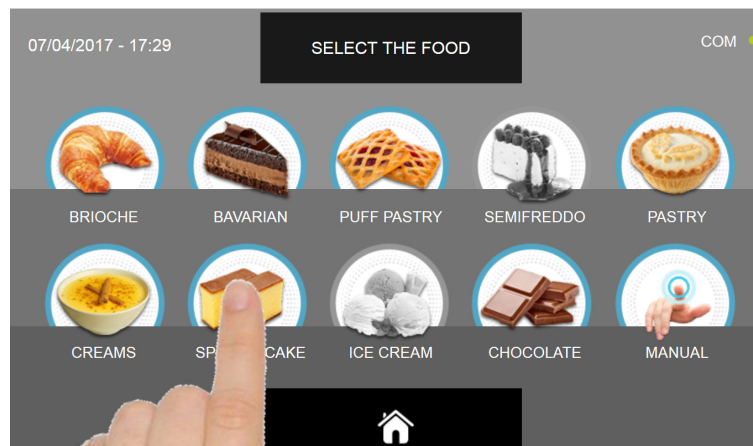

Select one of the food categories in the menu.



Select the setting icon of a CUSTOM cycle

MULTI-PURPOSE BLAST CHILLER EVOLUTION

There are two type of CUSTOM cycles :

- a- Time custom cycle (Preferred choice)
- b- Custom cycle with temperature probe

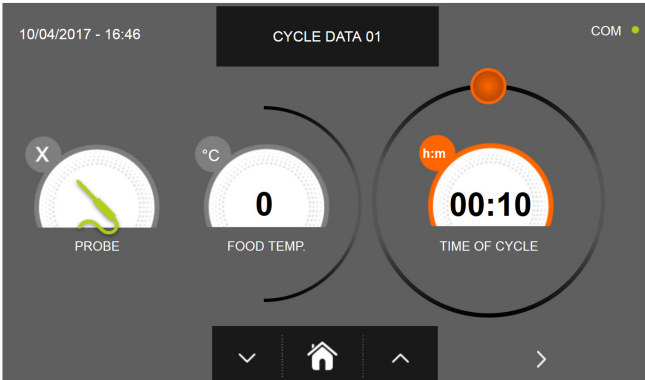

a- Time custom cycle

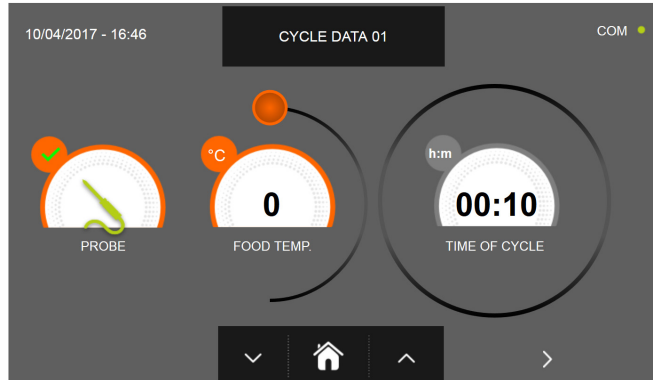

b- Custom cycle with temperature probe

N.B. To select the temperature probe cycle press the PROBE icon, to return to the time selection press the PROBE icon again.

To set the Time or Temperature values, move the cursor as shown in the following pictures :

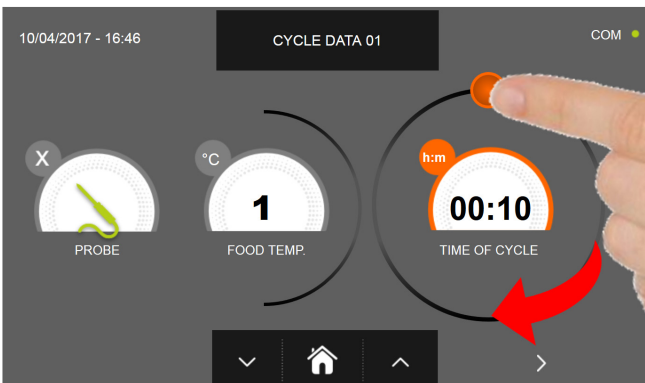

a- Cycle duration setting

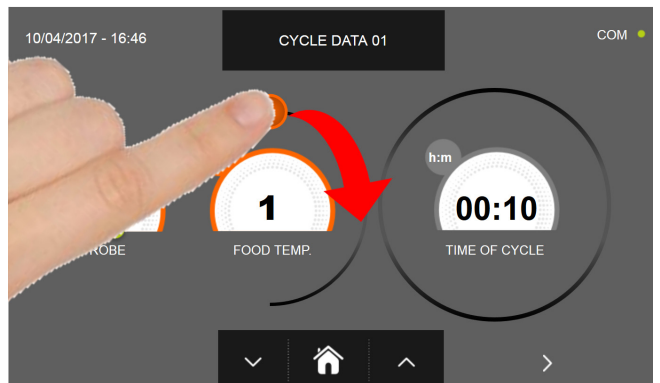

b- Temperature vale setting

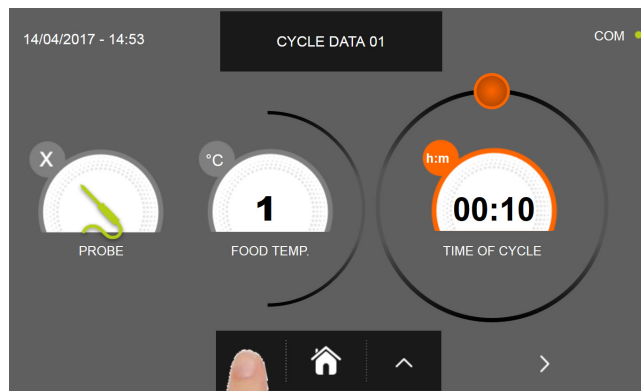

For the food temperature and time values, it is possible to finely set them by using the buttons





and

- Food temperature setting steps $\pm 1^{\circ}\text{C}$
- Cycle time setting steps ± 10 minuti

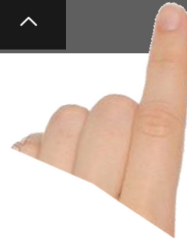
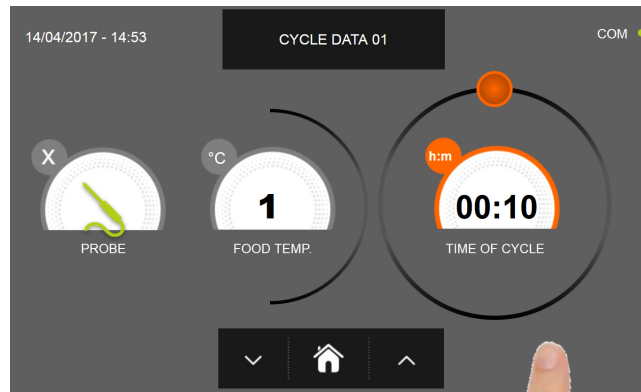
MULTI-PURPOSE BLAST CHILLER EVOLUTION



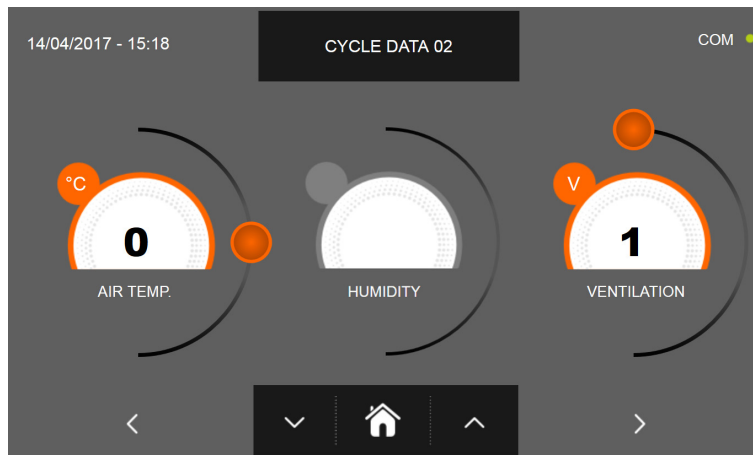

Press the icon  to proceed to the second programming page, press the icon  to go back to the previous page.



In the second programming page it is possible to set :

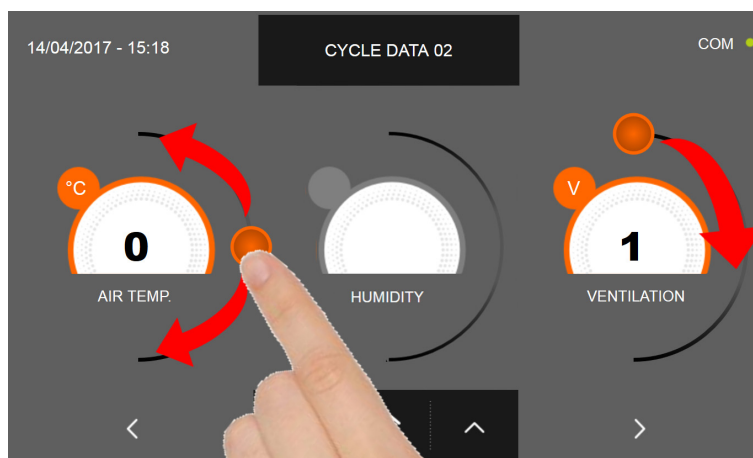

- Cell temperature
- Humidity (only for 1HUNDRED and cell temperatures > 0 ° C)
- Ventilation

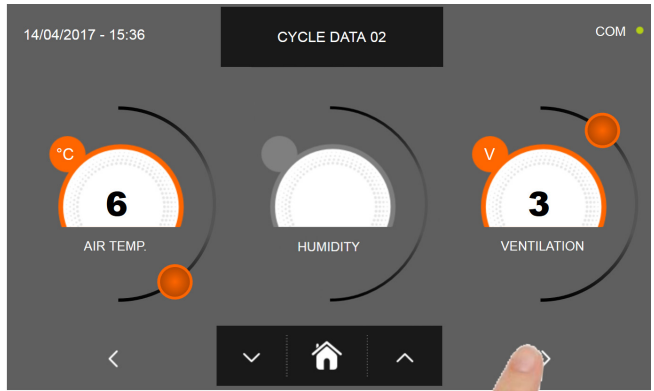

As per the values set in the first programming page, set the values by moving the cursor as indicated in the picture, or, after selecting the desired field, set the values with the icons  and .

MULTI-PURPOSE BLAST CHILLER EVOLUTION



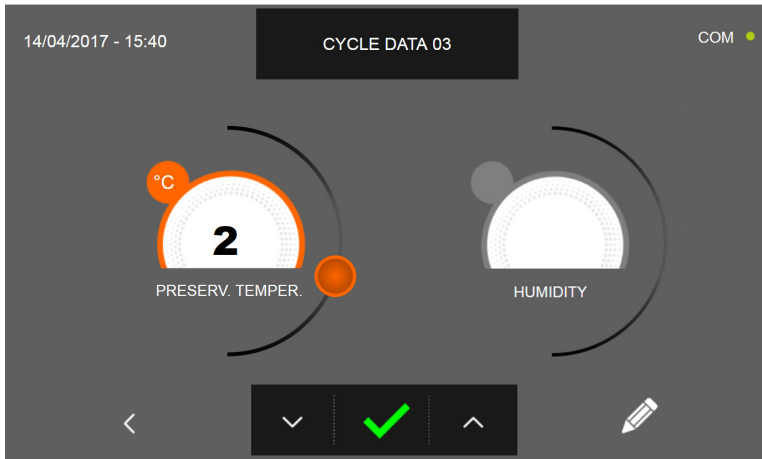

Press the icon  to proceed to the third programming page, press the icon  to go back to the previous page.





In the third programming page it is possible to set :
Preservation temperature at the end of the cycle
Humidity (only for 1HUNDRED and cell temperatures > 0 ° C)



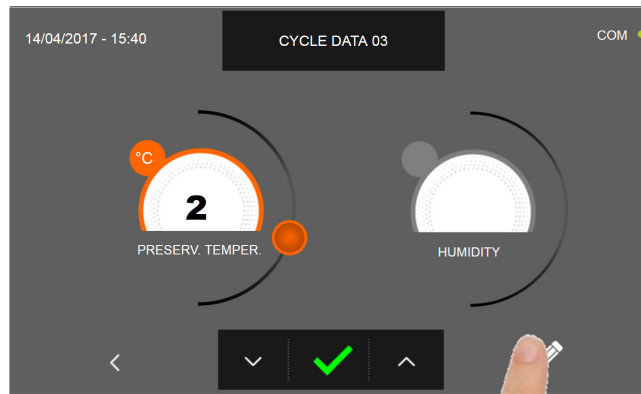

As per the values set in the first programming page, set the values by moving the cursor as indicated in the picture, or, after selecting the desired field, set the values with the icons  and 

MULTI-PURPOSE BLAST CHILLER EVOLUTION

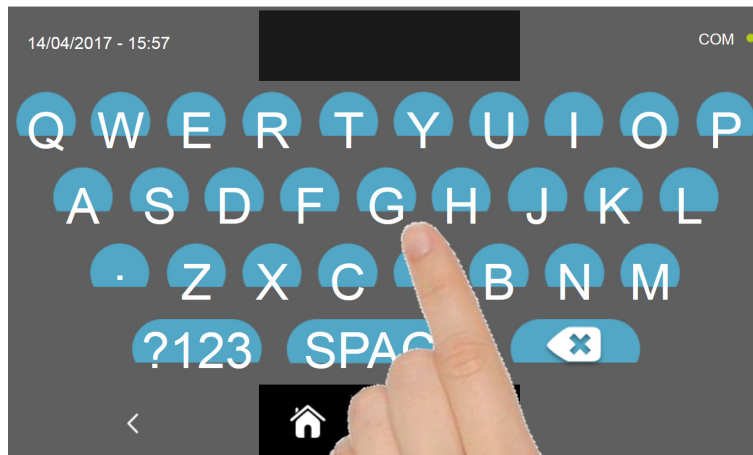

Press the icon  to record the name of a custom cycle and store it for future use.



With the keyboard enter the name of the cycle and then press the icon  to go back to the last programming page.

To delete the cycle just set, before starting the cycle itself, press the icon .

MULTI-PURPOSE BLAST CHILLER EVOLUTION

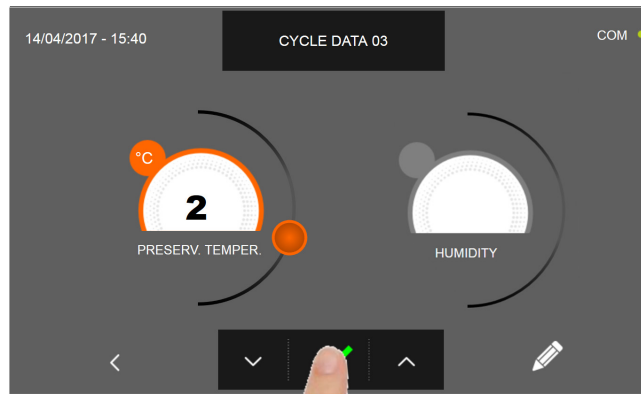

If a custom time cycle was chosen, after pressing the icon  the functioning data screen will be displayed. Refer to paragraph 15 - OPERATION CYCLES to display the temperature chart, input / output, parameter list or multilevel function.

The cycle will end after the set time has elapsed. The end of the cycle is communicated with a buzzer that emits a sound. Press on the display to silence the buzzer. Alternatively, the buzzer automatically mutes after 60 seconds. Once the cycle is finished, the machinery will automatically enter the PRESERVATION mode

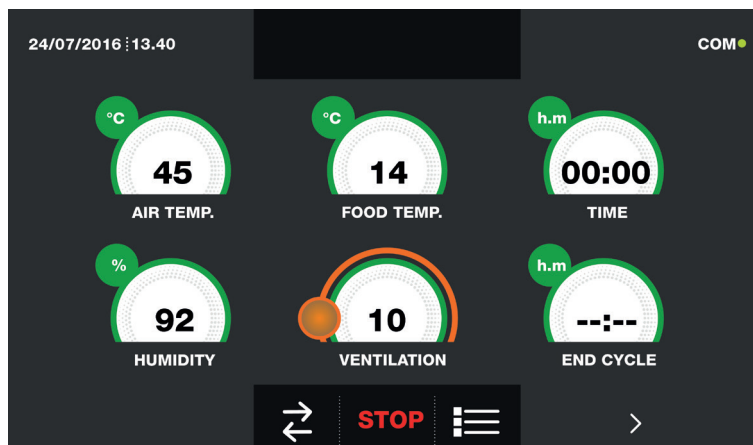

If otherwise the temperature cycle was chosen, after pressing the icon  you will be requested to place the food probe. Refer to paragraph 15 - OPERATION CYCLES to display the temperature chart, input / output, parameter list or multilevel function.

During the cycle, by moving the cursor as shown in the figure, the ventilation value can be varied, with set 1 ÷ 10:

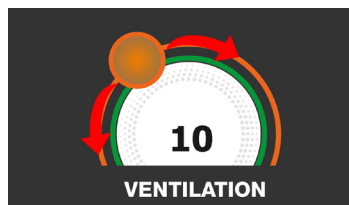

Once you have placed the food probe and after the machinery has correctly sensed the probe positioning, the cycle will start and the functioning screen will be displayed. The cycle will finish when the temperature at the core of the product will be lower or equal to the temperature set. The end of the cycle will be communicated with a buzzer that emits a sound. Press on the display to silence the buzzer. Alternatively, the buzzer automatically mutes after 60 seconds. Once the cycle is finished, the machinery will automatically enter the PRESERVATION mode.

We remind you that this phase can be maintained for a maximum recommended period of 24 hours.

16.12 - MANUAL THAWING CYCLE

The THAWING cycle is used to raise the temperature of food from a negative to a positive value.

With the machinery in STAND-BY mode, press the power icon as described in chapter 16.1. Once you have access to the HOME PAGE, proceed as follows:

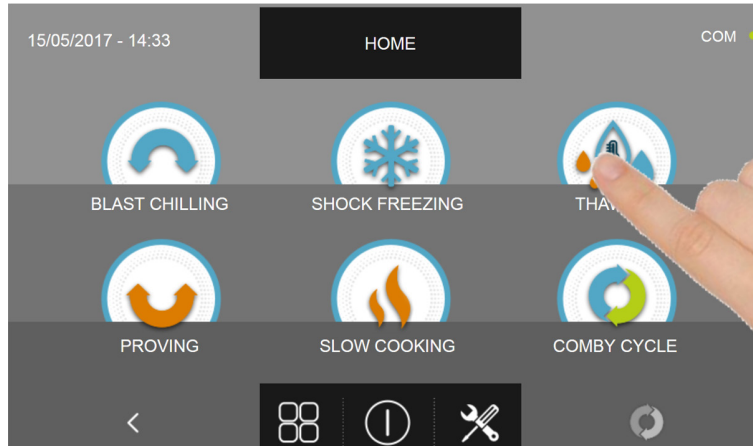

Press the THAWING icon to access its selection menu

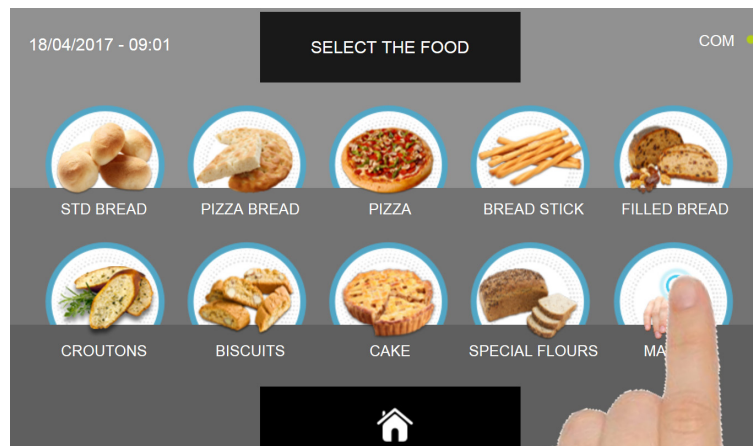

Select the icon MANUAL

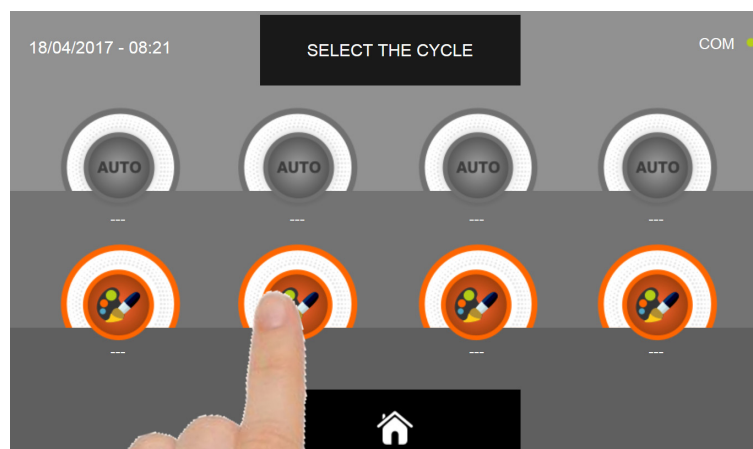

Select the setting icon of a CUSTOM cycle

N.B. THE AUTOMATIC CYCLES ARE NOT AVAILABLE

MULTI-PURPOSE BLAST CHILLER EVOLUTION

There are two type of MANUAL cycles :

- a- Time manual cycle (Preferred choice)
- b- Manual cycle with temperature probe

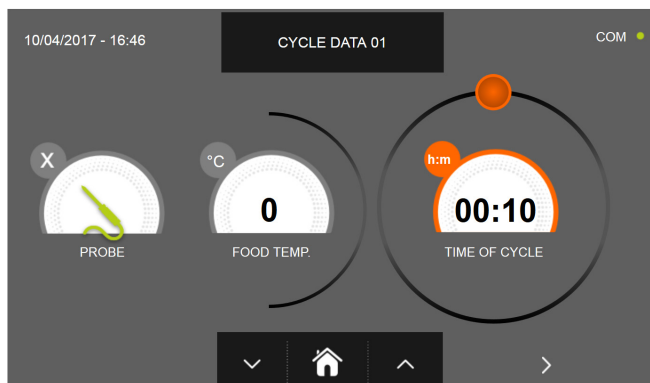

a- Time manual cycle

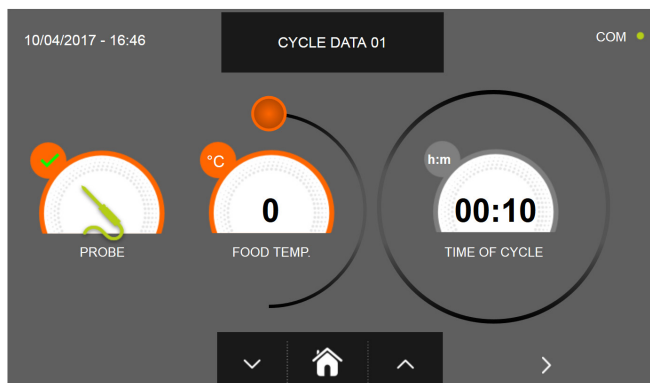

b- Manual cycle with temperature probe

N.B. To select the temperature probe cycle press the PROBE icon, to return to the time selection press the PROBE icon again.

To set the Time or Temperature values, move the cursor as shown in the following pictures :

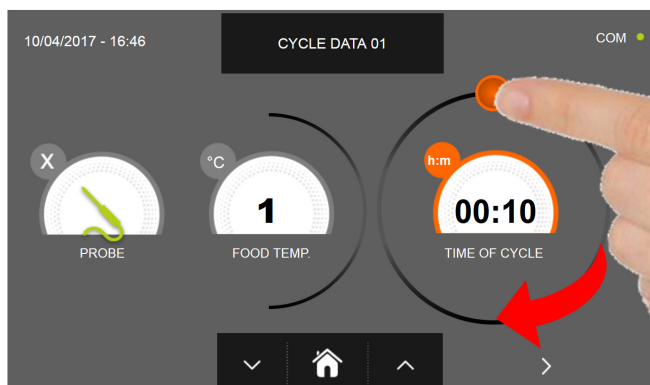

a- Cycle duration setting



b- Temperature vale setting



For the food temperature and time values, it is possible to finely set them by using the buttons





and

- Food temperature setting steps $\pm 1^{\circ}\text{C}$
- Cycle time setting steps ± 10 minuti

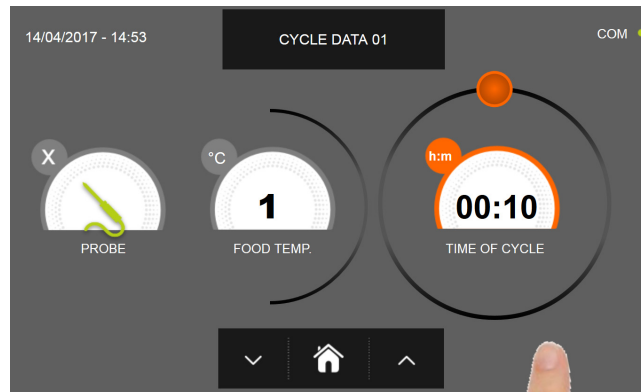
MULTI-PURPOSE BLAST CHILLER EVOLUTION



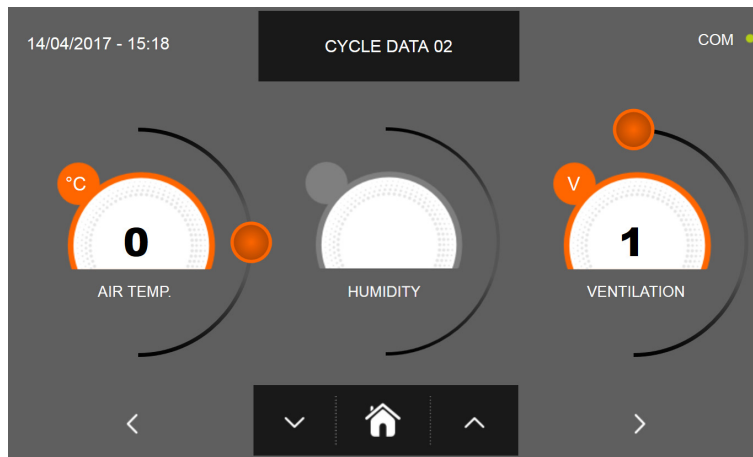

Press the icon  to proceed to the second programming page, press the icon  to go back to the previous page



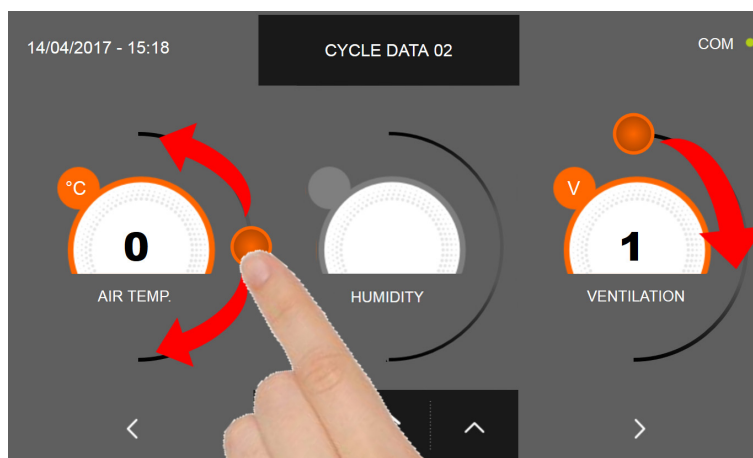

In the second programming page it is possible to set :
 Cell temperature
 Humidity (only for 1HUNDRED and cell temperatures > 0 ° C)
 Ventilation

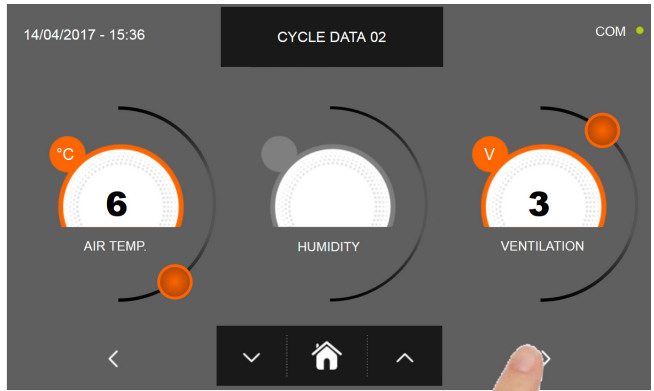

As per the values set in the first programming page, set the values by moving the cursor as indicated in the picture, or, after selecting the desired field, set the values with the icons  and 

MULTI-PURPOSE BLAST CHILLER EVOLUTION



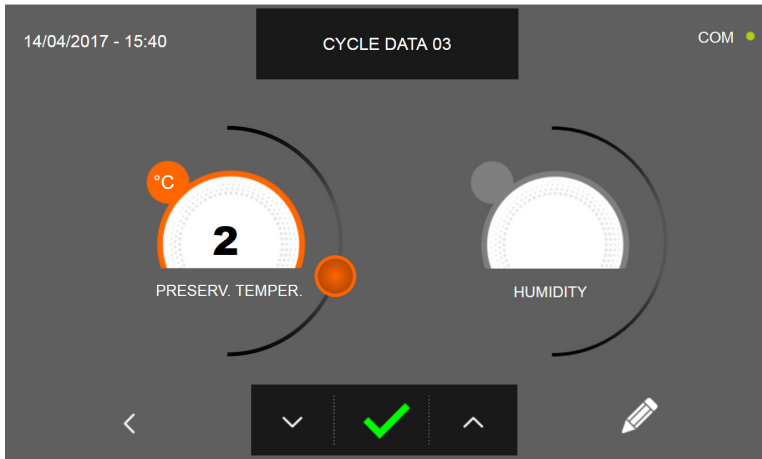

Press the icon  to proceed to the third programming page, press the icon  to go back to the previous page.





In the third programming page it is possible to set :
 Preservation temperature at the end of the cycle
 Humidity (only for 1HUNDRED and cell temperatures > 0 ° C)



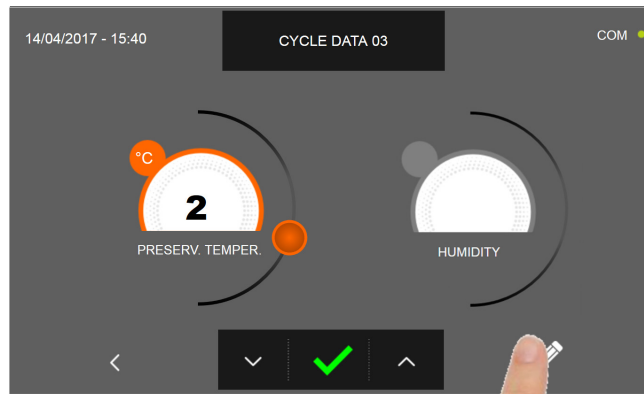

As per the values set in the first programming page, set the values by moving the cursor as indicated in the picture, or, after selecting the desired field, set the values with the icons  and 

MULTI-PURPOSE BLAST CHILLER EVOLUTION

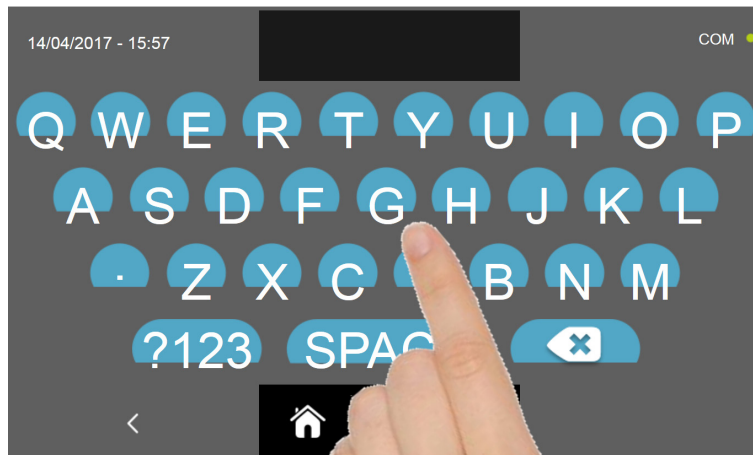

Press the icon  to record the name of a custom cycle and store it for future use.



With the keyboard enter the name of the cycle and then press the icon  to go back to the last programming page.

To delete the cycle just set, before starting the cycle itself, press the icon .

MULTI-PURPOSE BLAST CHILLER EVOLUTION

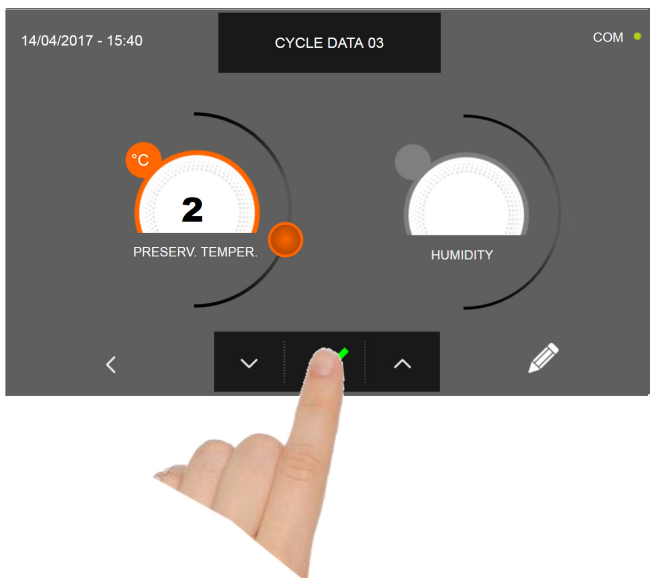

If a manual time cycle was chosen, after pressing the icon  the functioning data screen will be displayed. Refer to paragraph 15 - OPERATION CYCLES to display the temperature chart, input / output, parameter list or multilevel function. The cycle will end after the set time has elapsed. The end of the cycle is communicated with a buzzer that emits a sound. Press on the display to silence the buzzer. Alternatively, the buzzer automatically mutes after 60 seconds. Once the cycle is finished, the machinery will automatically enter the PRESERVATION mode

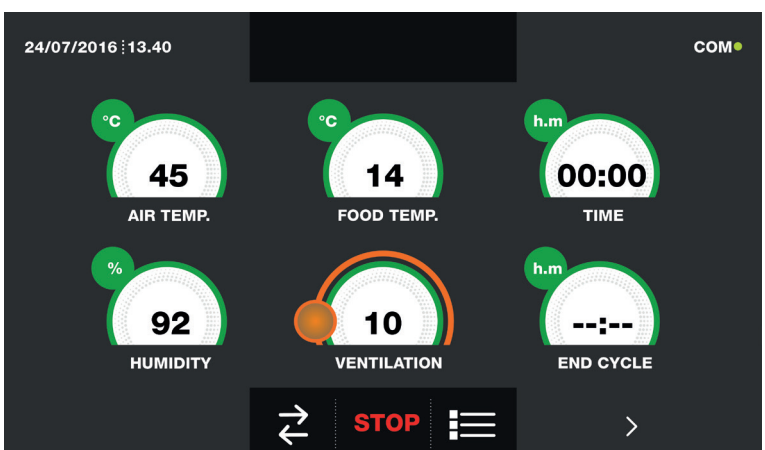

If otherwise the manual temperature cycle was chosen, after pressing the icon  you will be requested to place the food probe. Refer to paragraph 15 - OPERATION CYCLES to display the temperature chart, input / output, parameter list or multilevel function. During the cycle, by moving the cursor as shown in the figure, the ventilation value can be varied, with set 1 ÷ 10:

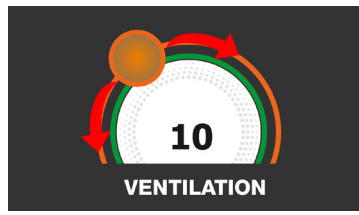

Once you have placed the food probe and after the machinery has correctly sensed the probe positioning, the cycle will start and the functioning screen will be displayed. The cycle will finish when the temperature at the core of the product will be lower or equal to the temperature set. The end of the cycle will be communicated with a buzzer that emits a sound. Press on the display to silence the buzzer. Alternatively, the buzzer automatically mutes after 60 seconds. Once the cycle is finished, the machinery will automatically enter the PRESERVATION mode.

We remind you that this phase can be maintained for a maximum recommended period of 24 hours.

16.13 - CUSTOM PROVING CYCLE

The PROVING cycle is used to bring the cell temperature between +15°C and +45°C.

With the machinery in STAND-BY mode, press the power icon as described in chapter 16.1. Once you have access to the HOME PAGE, proceed as follows:

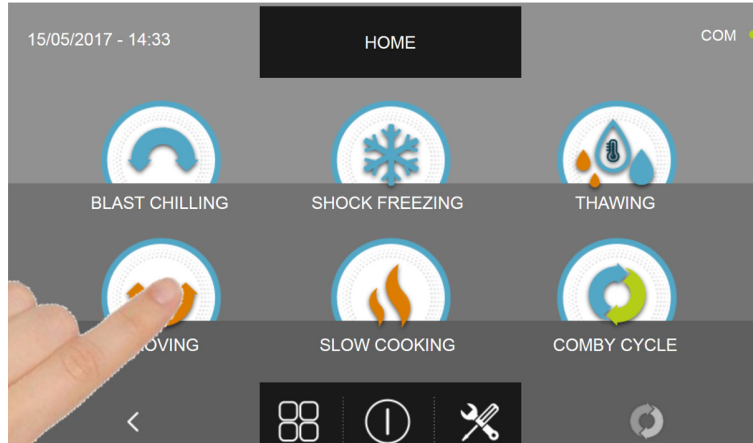

Press the PROVING icon to access its selection menu

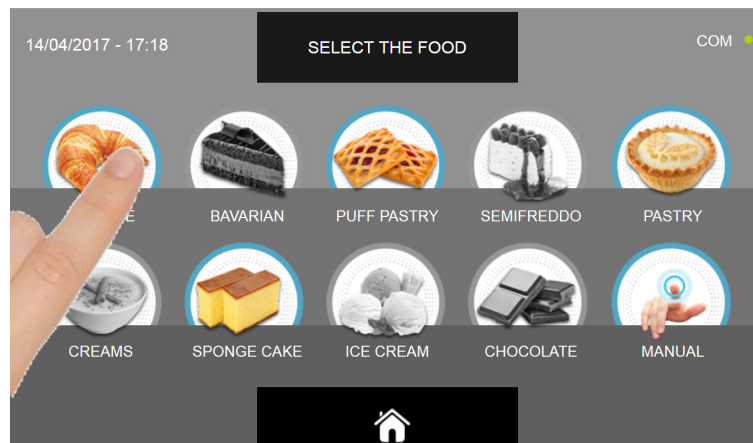

Select one of the food categories in the menu.

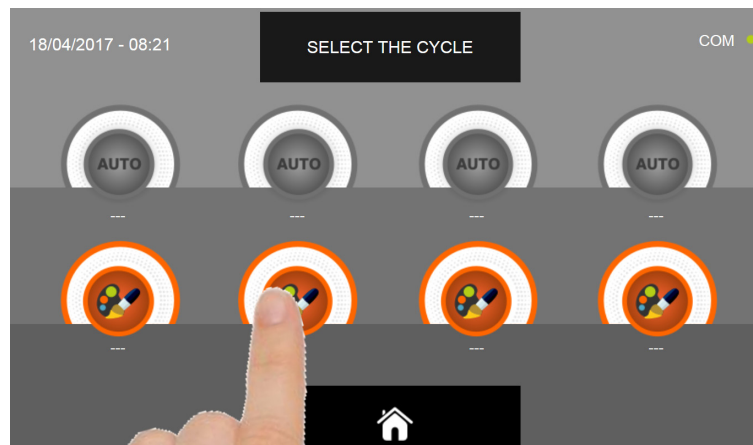

Select the setting icon of a CUSTOM cycle

N.B. THE AUTOMATIC CYCLES ARE NOT AVAILABLE

MULTI-PURPOSE BLAST CHILLER EVOLUTION

The CUSTOM cycles are only by time

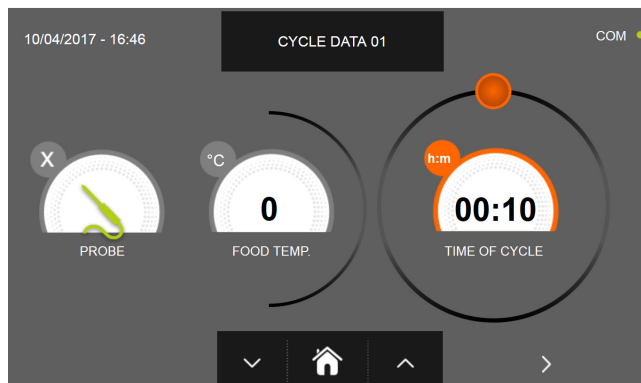

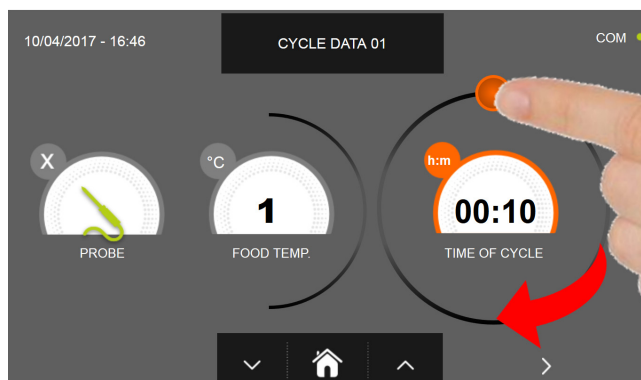

Time custom cycle



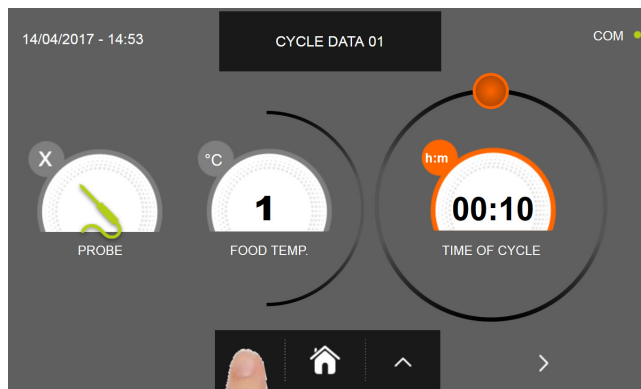

To set the duration of the cycle move the cursor as indicated in the picture

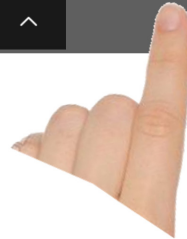
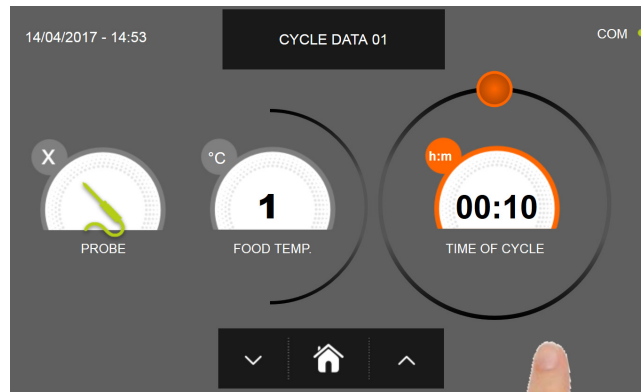

It is possible to finely set the time by using the buttons  and  in steps ± 10 minutes

MULTI-PURPOSE BLAST CHILLER EVOLUTION



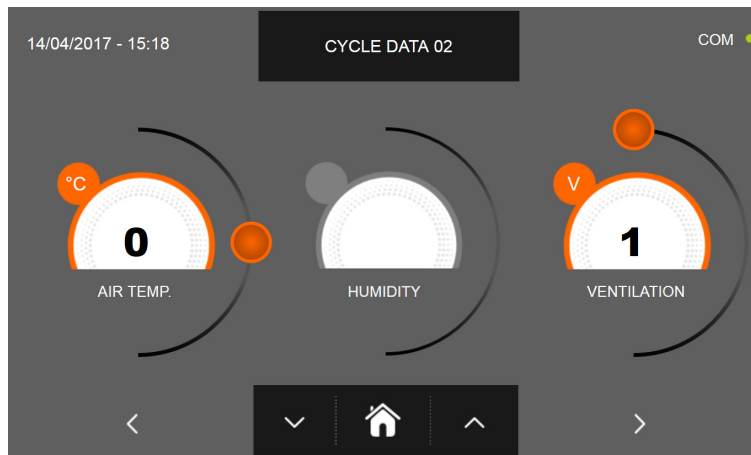

Press the icon  to proceed to the second programming page, press the icon  to go back to the previous page.

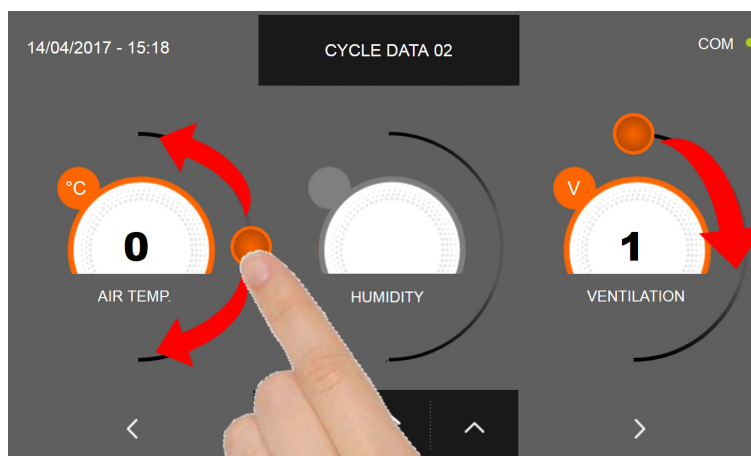

In the second programming page it is possible to set :

- Cell temperature
- Humidity (only for 1HUNDRED and cell temperatures > 0 ° C)
- Ventilation



As per the values set in the first programming page, set the values by moving the cursor as indicated in the picture, or, after selecting the desired field, set the values with the icons  and 

MULTI-PURPOSE BLAST CHILLER EVOLUTION



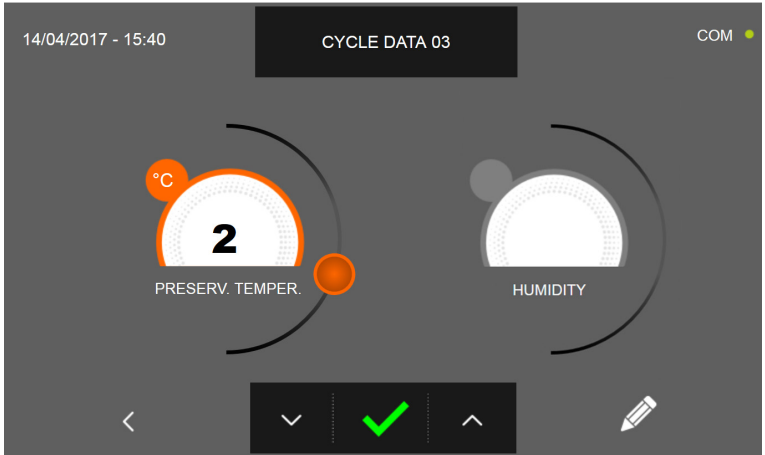

Press the icon  to proceed to the third programming page, press the icon  to go back to the previous page.



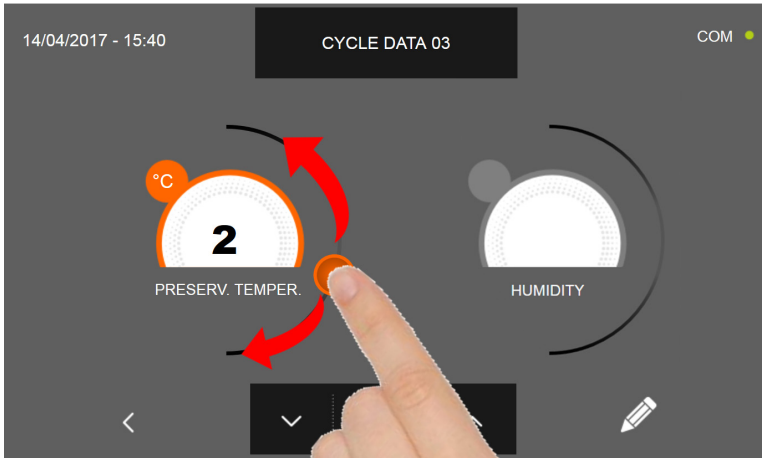

In the third programming page it is possible to set :
Preservation temperature at the end of the cycle
Humidity (only for 1HUNDRED and cell temperatures > 0 ° C)



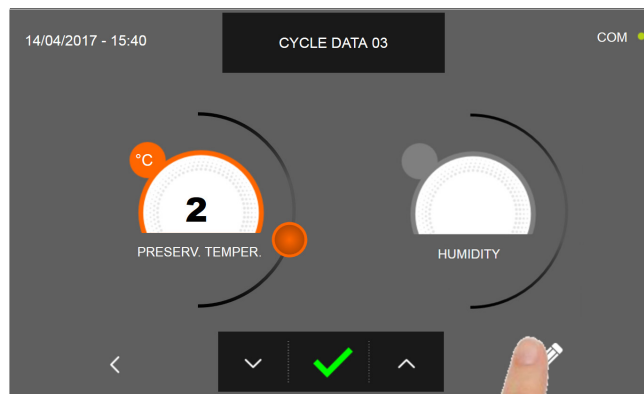

As per the values set in the first programming page, set the values by moving the cursor as indicated in the picture, or, after selecting the desired field, set the values with the icons  and 

MULTI-PURPOSE BLAST CHILLER EVOLUTION

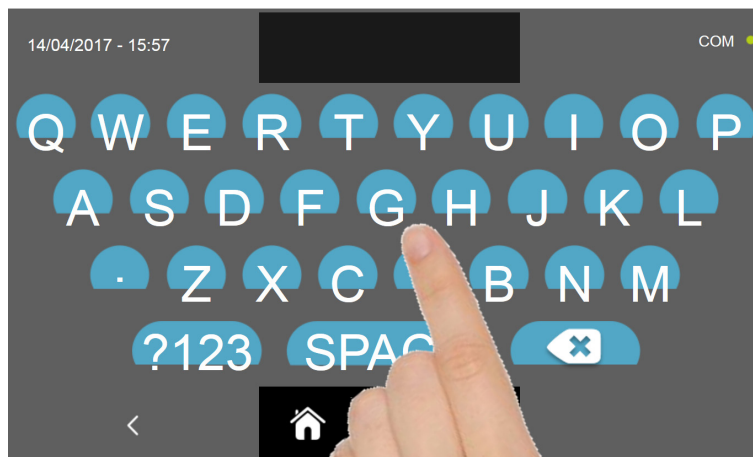

Press the icon  to record the name of a custom cycle and store it for future use.



With the keyboard enter the name of the cycle and then press the icon  to go back to the last programming page.

To delete the cycle just set, before starting the cycle itself, press the icon .

MULTI-PURPOSE BLAST CHILLER EVOLUTION

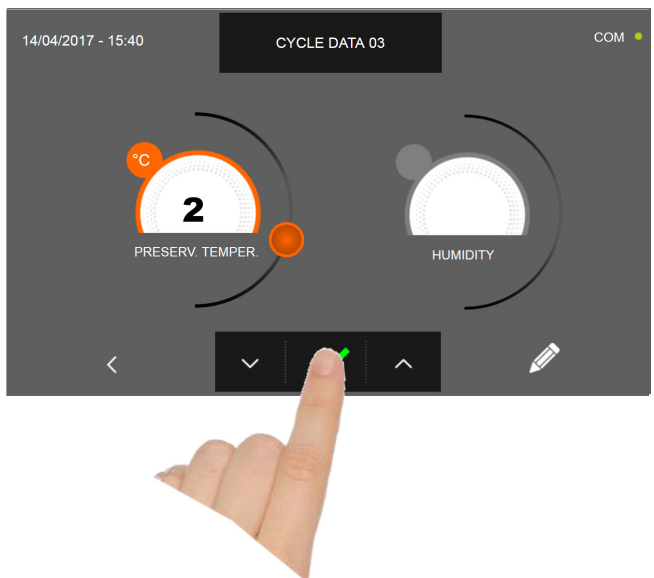

After pressing the icon  the functioning data screen will be displayed. Refer to paragraph 15 - OPERATION CYCLES to display the temperature chart, input / output, parameter list or multilevel function.

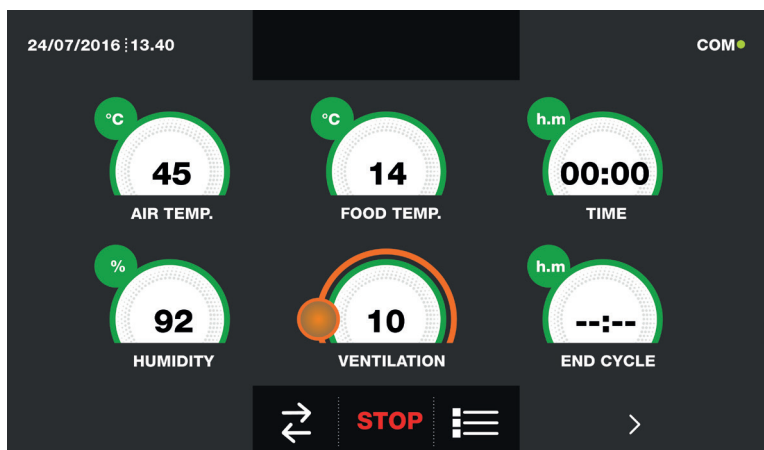

During the cycle, by moving the cursor as shown in the figure, the ventilation value can be varied, with set $1 \div 10$:



The cycle will end after the set time has elapsed. The end of the cycle is communicated with a buzzer that emits a sound. Press on the display to silence the buzzer. Alternatively, the buzzer automatically mutes after 60 seconds. Once the cycle is finished, the machinery will automatically enter the PRESERVATION mode.

We remind you that this phase can be maintained for a maximum recommended period of 24 hours.

16.14 - PROVING MANUAL CYCLE

The PROVING cycle is used to bring the cell temperature between +15°C and +45°C.

With the machinery in STAND-BY mode, press the power icon as described in chapter 16.1. Once you have access to the HOME PAGE, proceed as follows:

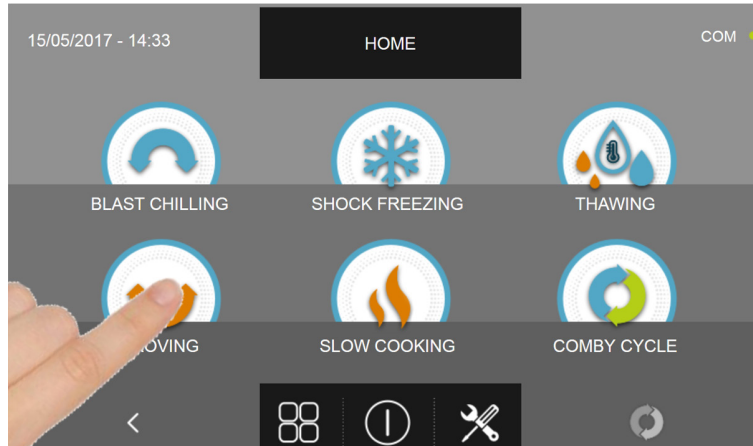

Press the PROVING icon to access its selection menu

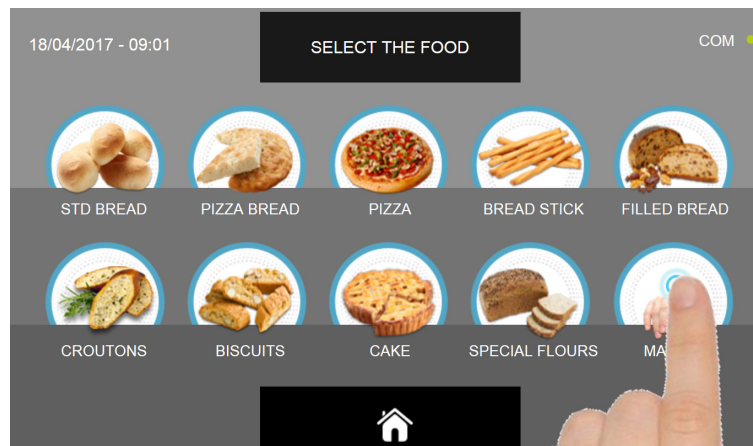

Select the icon MANUAL

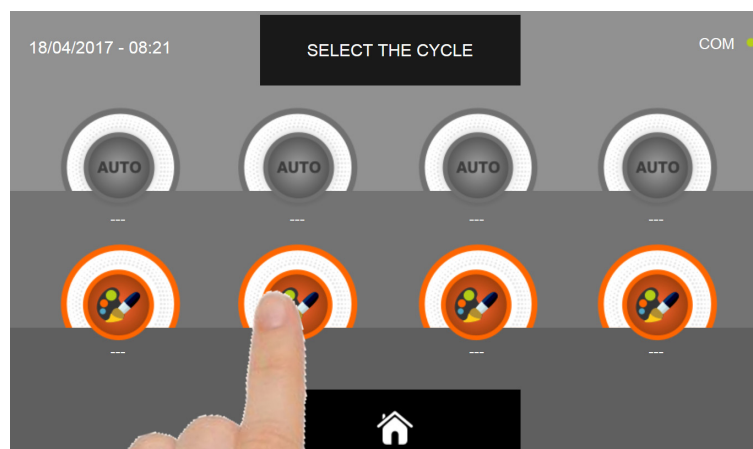

Select the setting icon of a CUSTOM cycle

N.B. THE AUTOMATIC CYCLES ARE NOT AVAILABLE

MULTI-PURPOSE BLAST CHILLER EVOLUTION

The MANUAL cycles is only by time

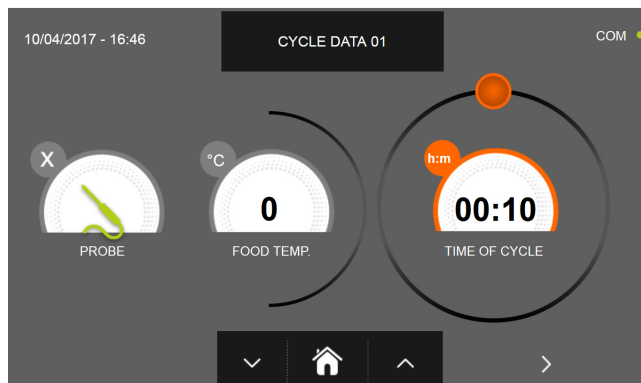

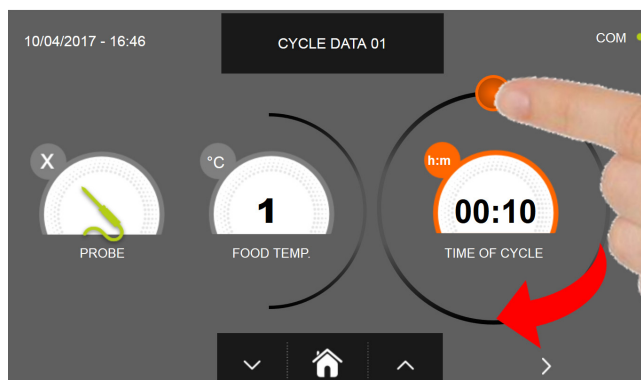

Time manual cycle



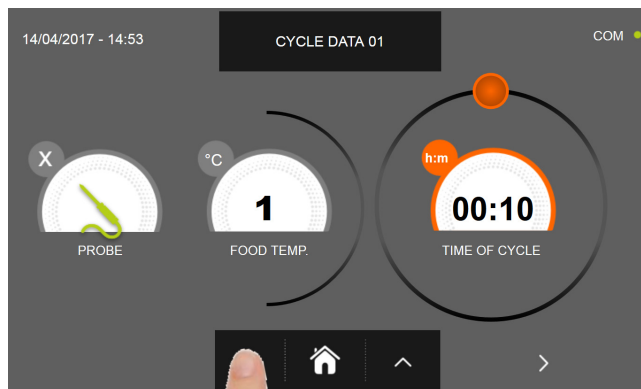

To set the duration of the cycle move the cursor as indicated in the picture

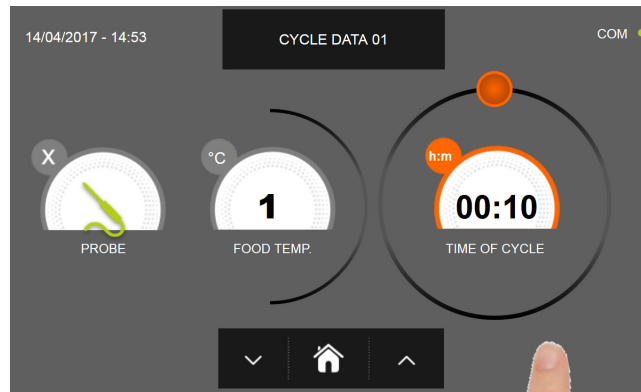

It is possible to finely set the time by using the buttons  and  in steps ± 10 minutes

MULTI-PURPOSE BLAST CHILLER EVOLUTION



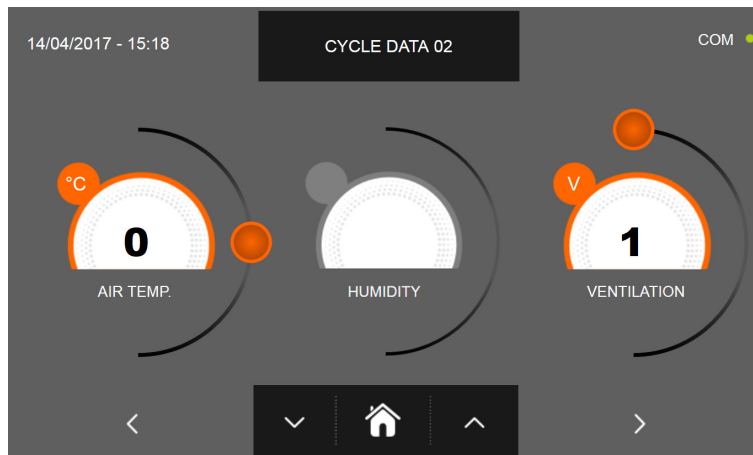

Press the icon  to proceed to the second programming page, press the icon  to go back to the previous page



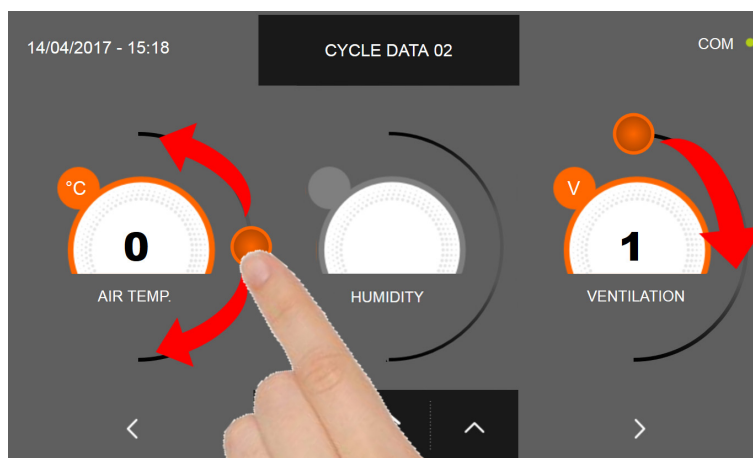

In the second programming page it is possible to set :
 Cell temperature
 Humidity (only for 1HUNDRED and cell temperatures > 0 ° C)
 Ventilation



As per the values set in the first programming page, set the values by moving the cursor as indicated in the picture, or, after selecting the desired field, set the values with the icons  and 

MULTI-PURPOSE BLAST CHILLER EVOLUTION



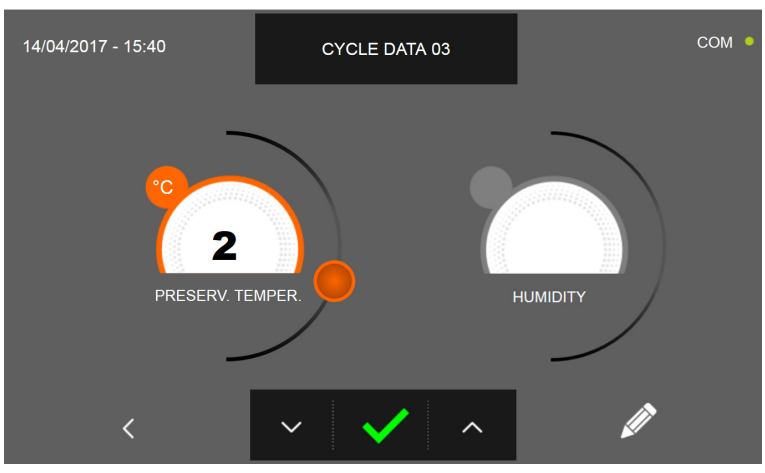

Press the icon  to proceed to the third programming page, press the icon  to go back to the previous page.



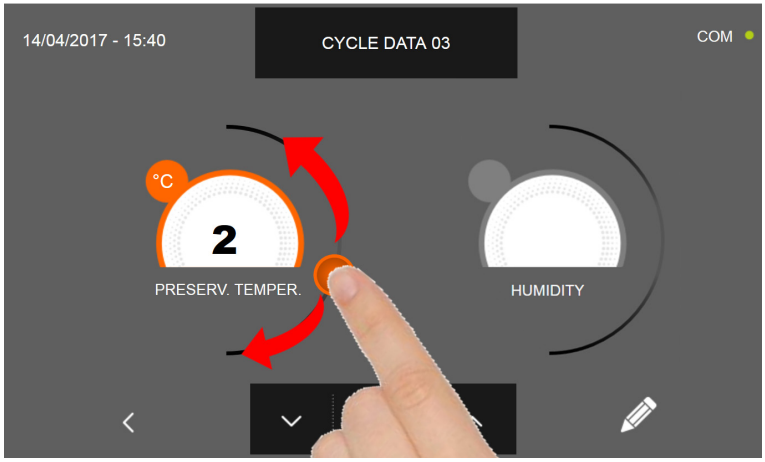

In the third programming page it is possible to set :
Preservation temperature at the end of the cycle
Humidity (only for 1HUNDRED and cell temperatures > 0 ° C)



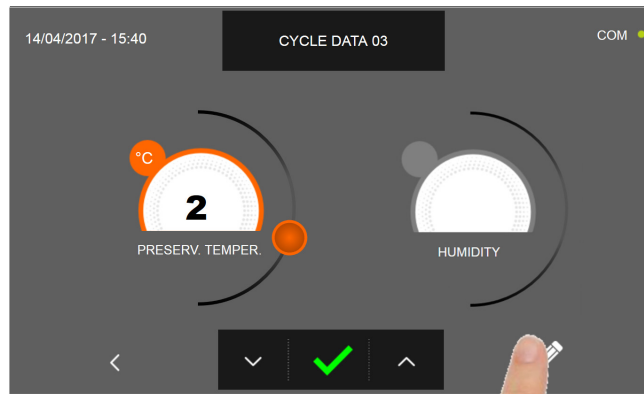

As per the values set in the first programming page, set the values by moving the cursor as indicated in the picture, or, after selecting the desired field, set the values with the icons  and 

MULTI-PURPOSE BLAST CHILLER EVOLUTION

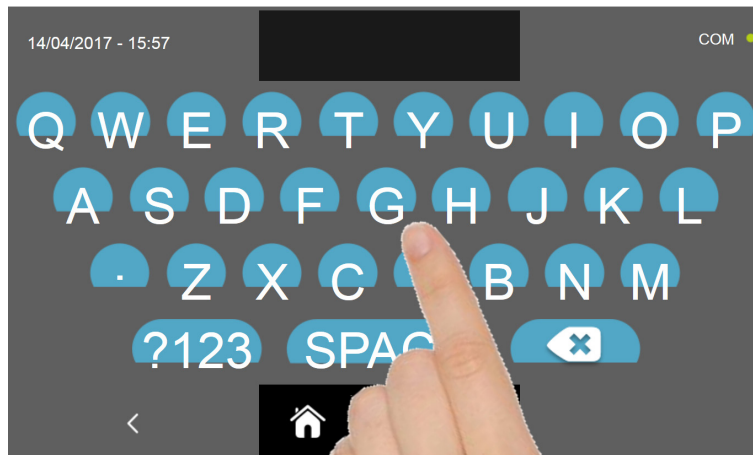

Press the icon  to record the name of a custom cycle and store it for future use.



With the keyboard enter the name of the cycle and then press the icon  to go back to the last programming page.

To delete the cycle just set, before starting the cycle itself, press the icon .

MULTI-PURPOSE BLAST CHILLER EVOLUTION

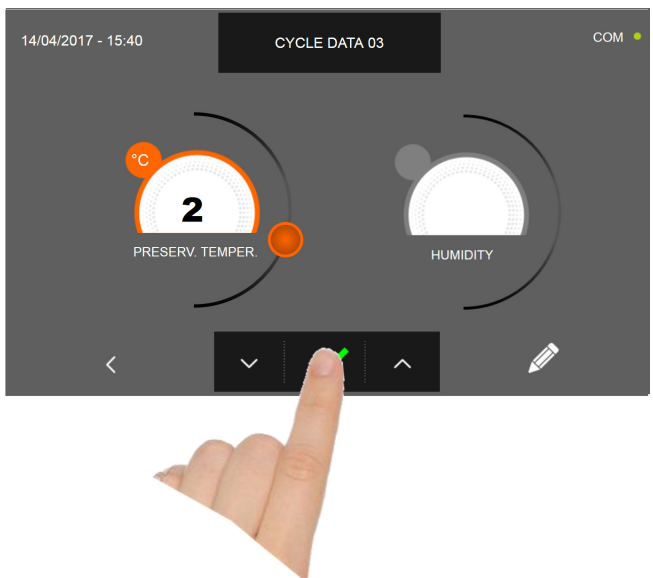

After pressing the icon  the functioning data screen will be displayed. Refer to paragraph 15 - OPERATION CYCLES to display the temperature chart, input / output, parameter list or multilevel function.

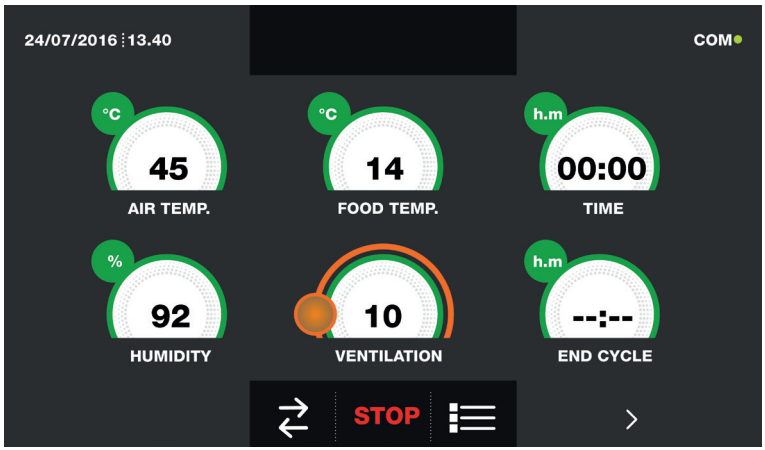

During the cycle, by moving the cursor as shown in the figure, the ventilation value can be varied, with set 1 ÷ 10:



The cycle will end after the set time has elapsed. The end of the cycle is communicated with a buzzer that emits a sound. Press on the display to silence the buzzer. Alternatively, the buzzer automatically mutes after 60 seconds. Once the cycle is finished, the machinery will automatically enter the PRESERVATION mode.

We remind you that this phase can be maintained for a maximum recommended period of 24 hours.

16.15 - AUTOMATIC SLOW COOKING CYCLE

The SLOW COOKING cycle (available only in ALL IN ONE models) is used to slow cook foods bringing the temperature at the core of the product up to a maximum of 75°C.

With the machinery in STAND-BY mode, press the power icon as described in chapter 16.1. Once you have access to the HOME PAGE, proceed as follows:

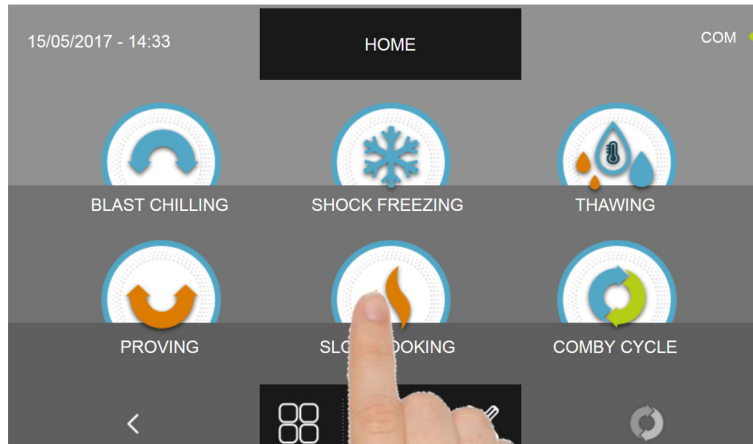

Press the SLOW COOKING icon to access its selection menu

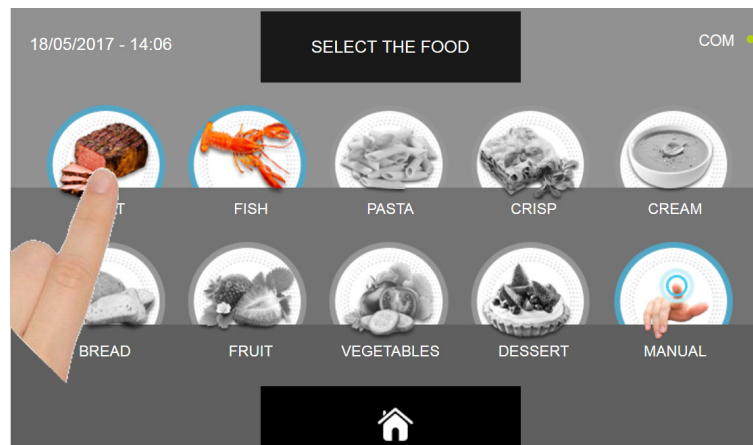

Select one of the food categories in the menu.

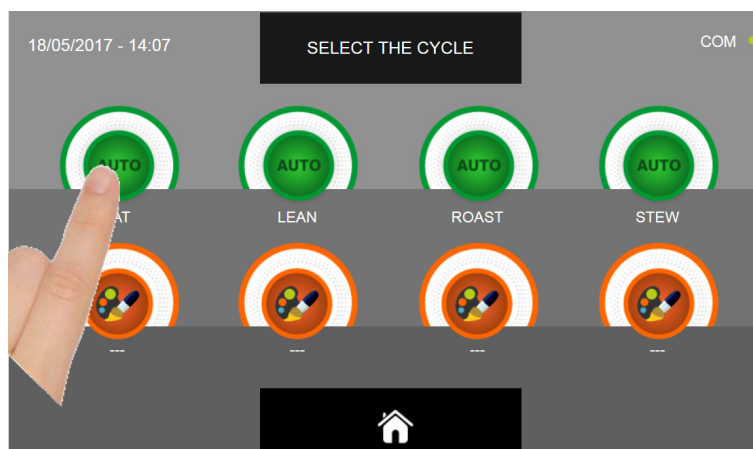

Select the green icon (AUTO) specific for the selected food.

MULTI-PURPOSE BLAST CHILLER EVOLUTION

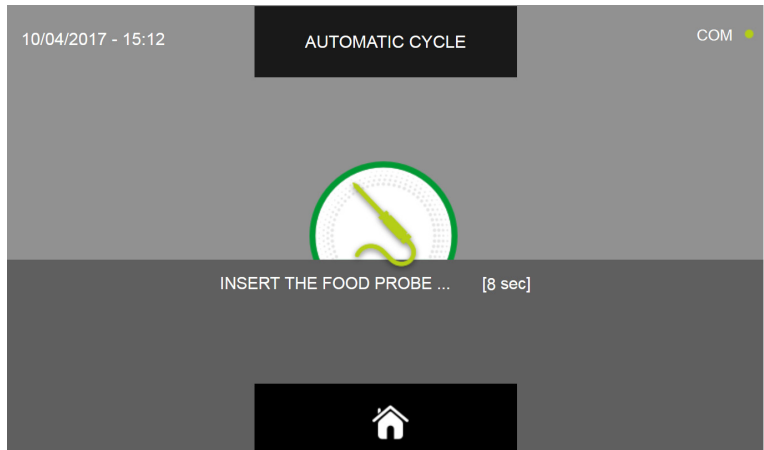

Once you have selected the type of food, you will be asked to place the food core probe. The cycle will automatically start after the probe is detected.

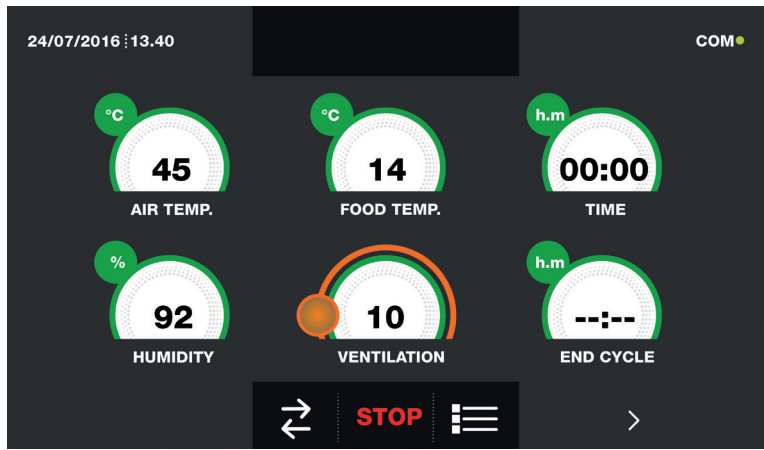

When the cycle is active, the screen with the operating data is displayed. Refer to paragraph 15 - OPERATION CYCLES to display the temperature chart, input / output, parameter list or multilevel function.

During the cycle, by moving the cursor as shown in the figure, the ventilation value can be varied, with set 1 ÷ 10 :



The cycle will finish when the temperature at the core of the product will be higher or equal to the pre-set temperature. The end of the cycle will be communicated with a buzzer that emits a sound. Press on the display to silence the buzzer. Alternatively, the buzzer automatically mutes after 60 seconds. Once the cycle is finished, the machinery will automatically enter the PRESERVATION mode.

We remind you that this phase can be maintained for a maximum recommended period of 24 hours.

16.16 - CUSTOM SLOW COOKING CYCLE

The SLOW COOKING custom cycle (available only in ALL IN ONE models) is used to slow cook foods according to the parameters set by the user.

With the machinery in STAND-BY mode, press the power icon as described in chapter 16.1. Once you have access to the HOME PAGE, proceed as follows:

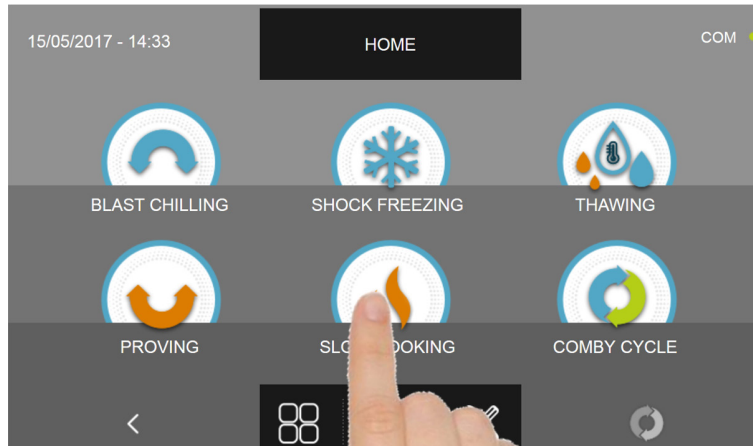

Press the SLOW COOKING icon to access its selection menu

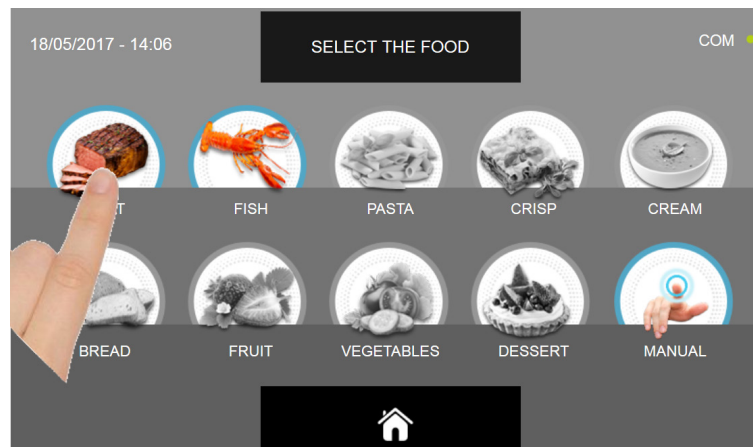

Select one of the food categories in the menu.

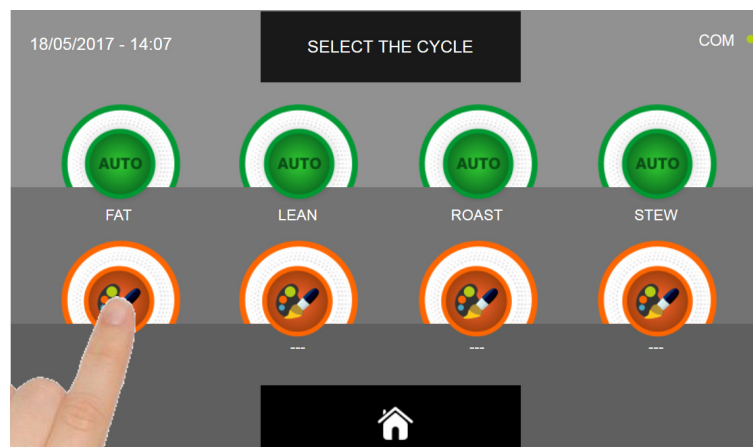

Select the setting icon of a CUSTOM cycle

MULTI-PURPOSE BLAST CHILLER EVOLUTION

There are two type of CUSTOM cycles :

- a- Time custom cycle (Preferred choice)
- b- Custom cycle with temperature probe

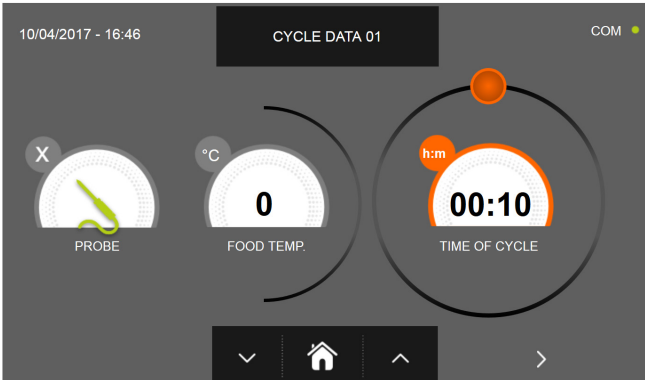

a- Time custom cycle

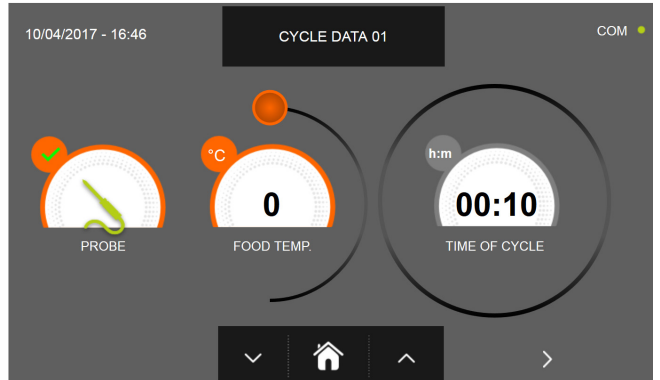

b- Custom cycle with temperature probe

N.B. To select the temperature probe cycle press the PROBE icon, to return to the time selection press the PROBE icon again.

To set the Time or Temperature values, move the cursor as shown in the following pictures :

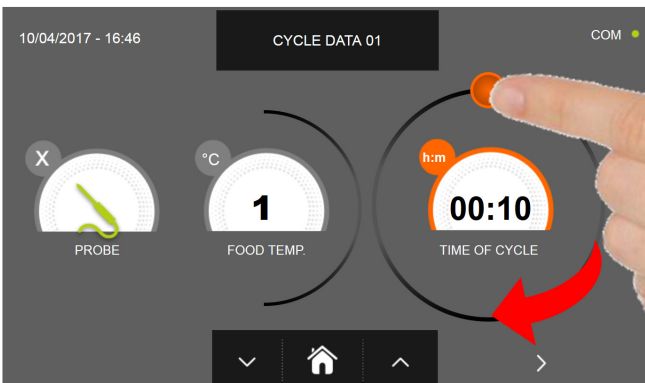

a- Cycle duration setting

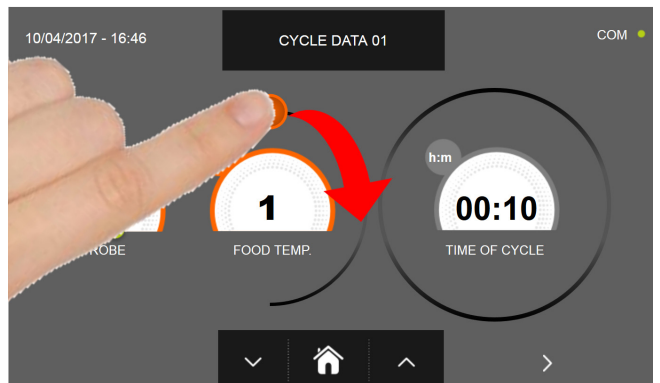

b- Temperature vale setting

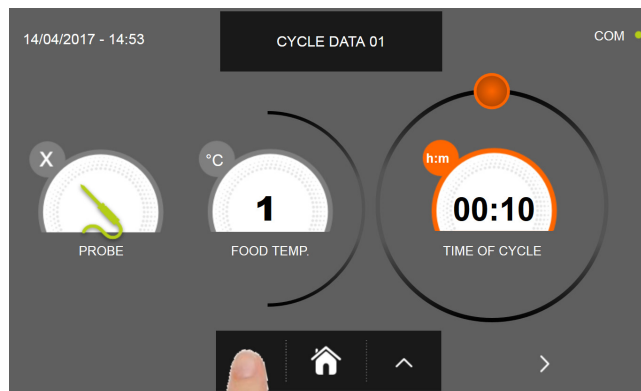

For the food temperature and time values, it is possible to finely set them by using the buttons





and

- Food temperature setting steps $\pm 1^{\circ}\text{C}$
- Cycle time setting steps ± 10 minuti

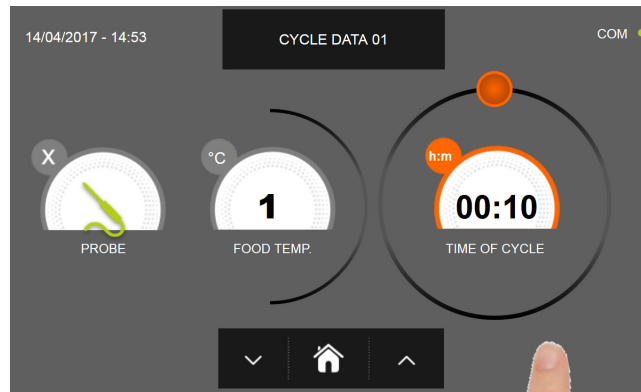
MULTI-PURPOSE BLAST CHILLER EVOLUTION



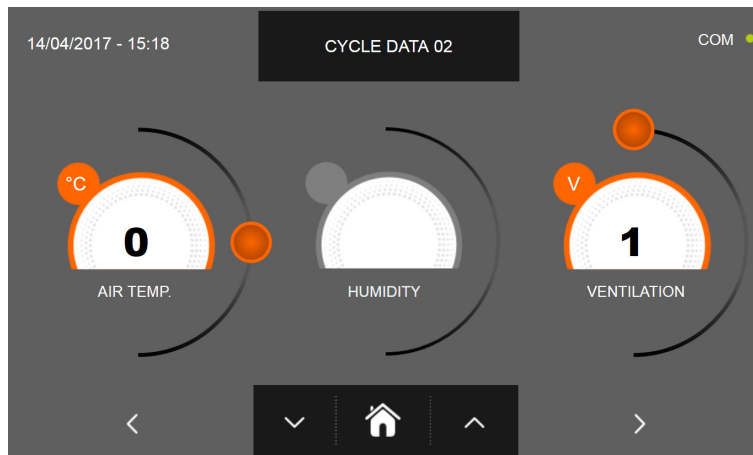

Press the icon  to proceed to the second programming page, press the icon  to go back to the previous page.



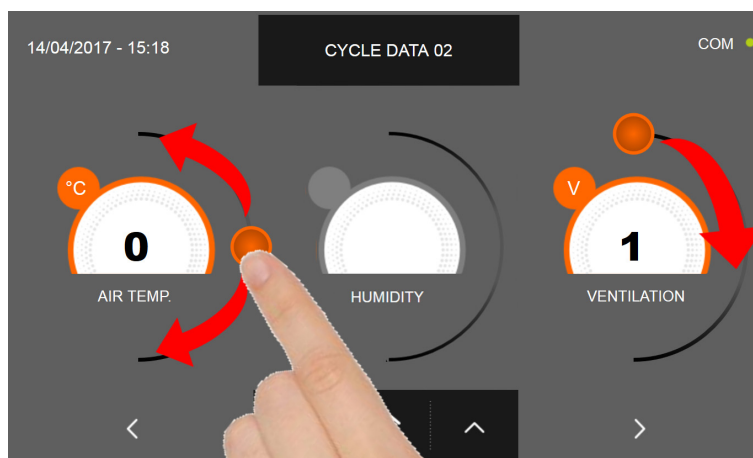

In the second programming page it is possible to set :
 Cell temperature
 Humidity (only for 1HUNDRED and cell temperatures > 0 ° C)
 Ventilation



As per the values set in the first programming page, set the values by moving the cursor as indicated in the picture, or, after selecting the desired field, set the values with the icons  and 

MULTI-PURPOSE BLAST CHILLER EVOLUTION



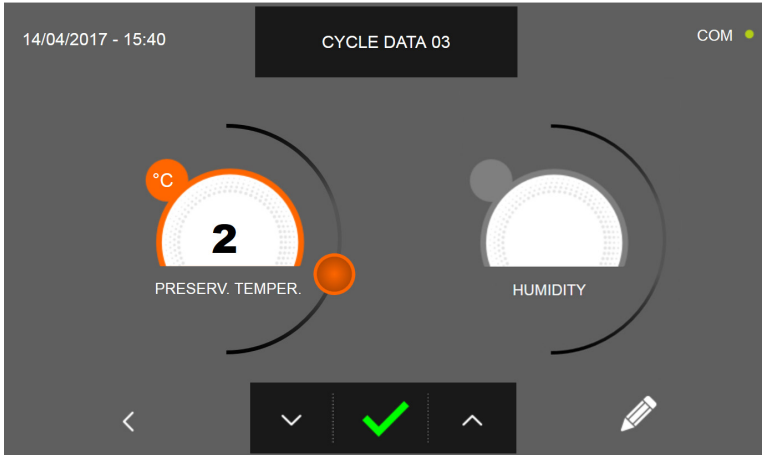

Press the icon  to proceed to the third programming page, press the icon  to go back to the previous page.



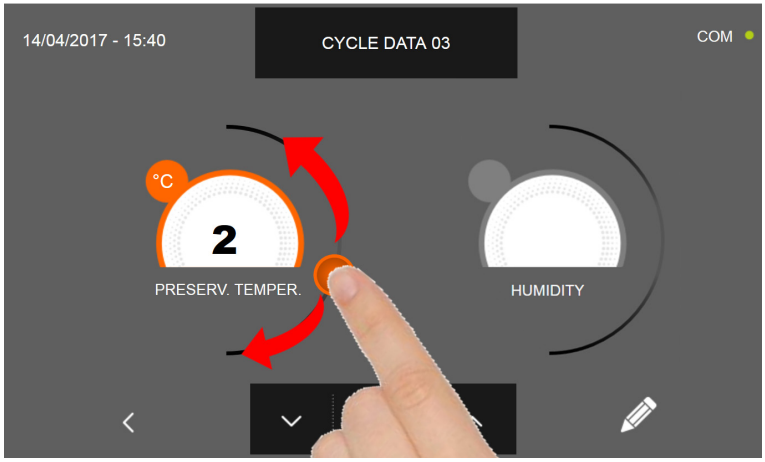

In the third programming page it is possible to set :
 Preservation temperature at the end of the cycle
 Humidity (only for 1HUNDRED and cell temperatures > 0 ° C)



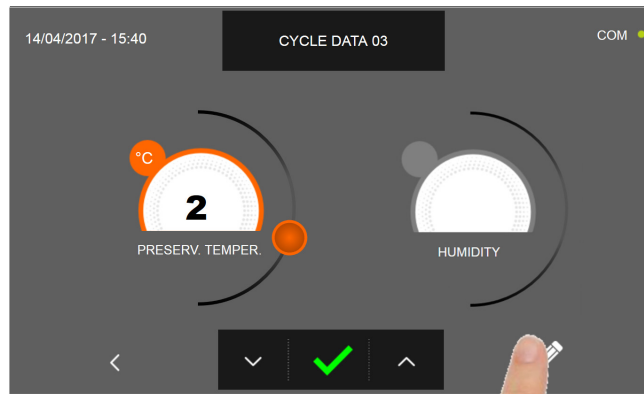

As per the values set in the first programming page, set the values by moving the cursor as indicated in the picture, or, after selecting the desired field, set the values with the icons  and 

MULTI-PURPOSE BLAST CHILLER EVOLUTION

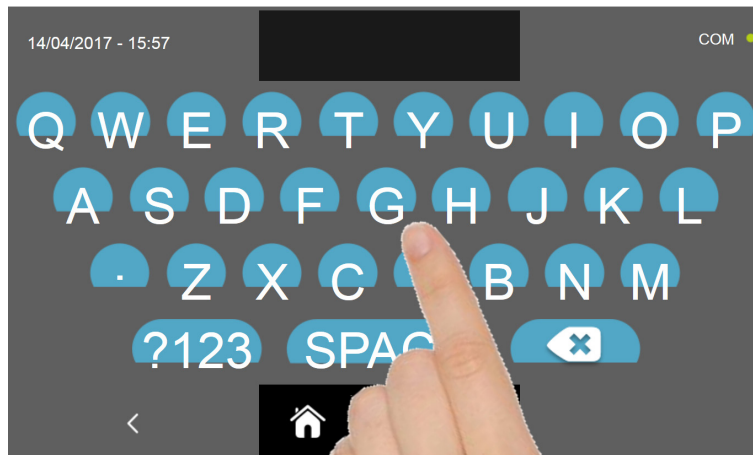

Press the icon  to record the name of a custom cycle and store it for future use.



With the keyboard enter the name of the cycle and then press the icon  to go back to the last programming page.

To delete the cycle just set, before starting the cycle itself, press the icon .

MULTI-PURPOSE BLAST CHILLER EVOLUTION

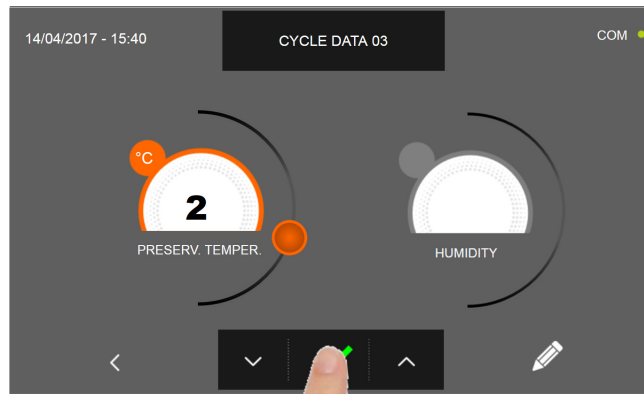

If a custom time cycle was chosen, after pressing the icon  the functioning data screen will be displayed. Refer to paragraph 15 - OPERATION CYCLES to display the temperature chart, input / output, parameter list or multilevel function.

The cycle will end after the set time has elapsed. The end of the cycle is communicated with a buzzer that emits a sound. Press on the display to silence the buzzer. Alternatively, the buzzer automatically mutes after 60 seconds. Once the cycle is finished, the machinery will automatically enter the PRESERVATION mode

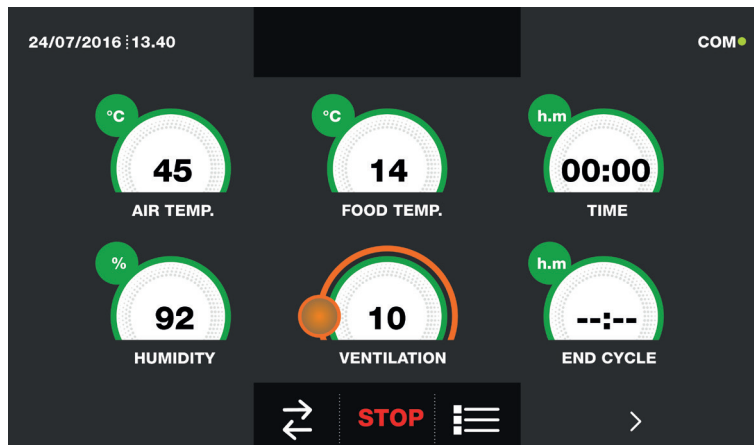

If otherwise the temperature cycle was chosen, after pressing the icon  you will be requested to place the food probe. Refer to paragraph 15 - OPERATION CYCLES to display the temperature chart, input / output, parameter list or multilevel function.

During the cycle, by moving the cursor as shown in the figure, the ventilation value can be varied, with set 1 ÷ 10:



Once you have placed the food probe and after the machinery has correctly sensed the probe positioning, the cycle will start and the functioning screen will be displayed. The cycle will finish when the temperature at the core of the product will be higher or equal to the temperature set. The end of the cycle will be communicated with a buzzer that emits a sound. Press on the display to silence the buzzer. Alternatively, the buzzer automatically mutes after 60 seconds. Once the cycle is finished, the machinery will automatically enter the PRESERVATION mode.

We remind you that this phase can be maintained for a maximum recommended period of 24 hours.

16.17 - SLOW COOKING MANUAL CYCLE

The SLOW COOKING custom cycle (available only in ALL IN ONE models) is used to slow cook foods according to the parameters set by the user.

With the machinery in STAND-BY mode, press the power icon as described in chapter 16.1. Once you have access to the HOME PAGE, proceed as follows:

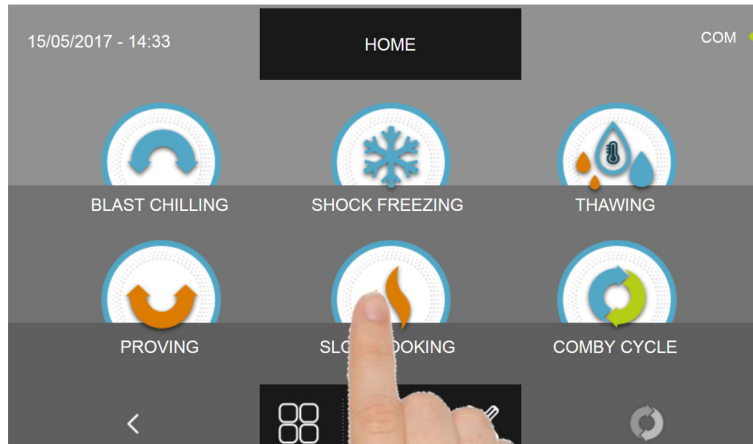

Press the SLOW COOKING icon to access its selection menu

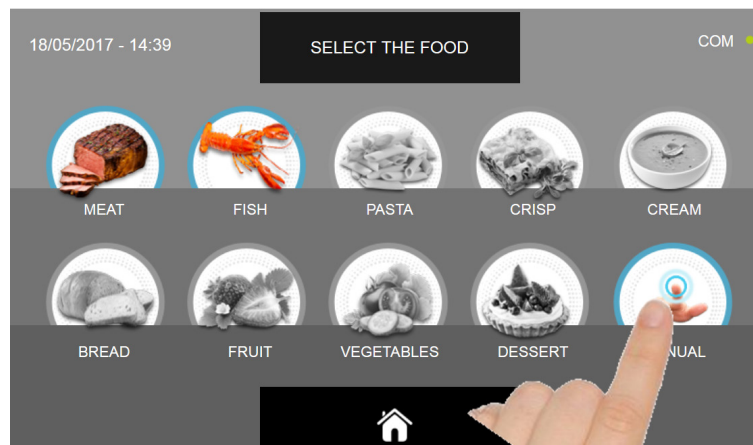

Select the icon MANUAL

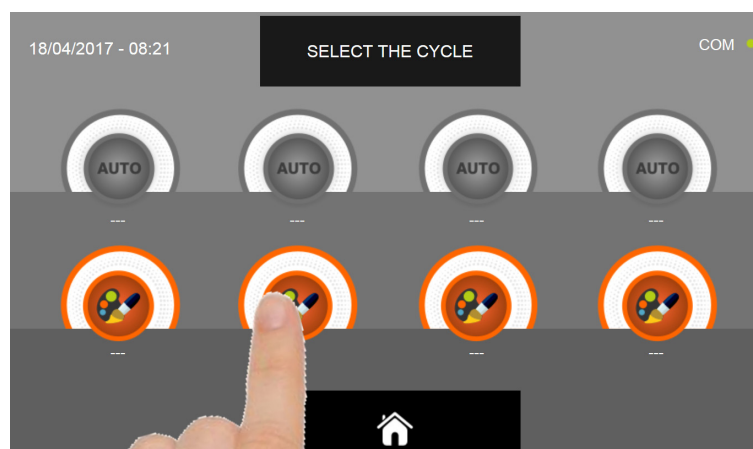

Select the setting icon of a CUSTOM cycle

N.B. THE AUTOMATIC CYCLES ARE NOT AVAILABLE

MULTI-PURPOSE BLAST CHILLER EVOLUTION

There are two type of MANUAL cycles :

- a- Time manual cycle (Preferred choice)
- b- Manual cycle with temperature probe

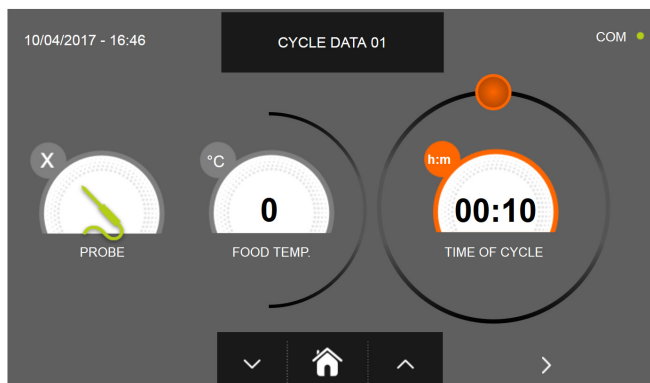

a- Time manual cycle

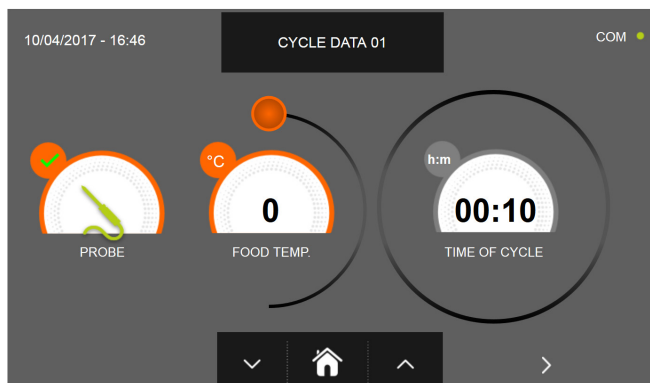

b- Manual cycle with temperature probe

N.B. To select the temperature probe cycle press the PROBE icon, to return to the time selection press the PROBE icon again.

To set the Time or Temperature values, move the cursor as shown in the following pictures :

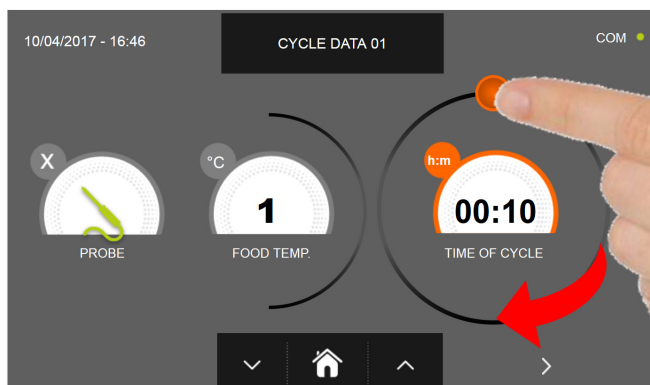

a- Cycle duration setting



b- Temperature vale setting





For the food temperature and time values, it is possible to finely set them by using the buttons

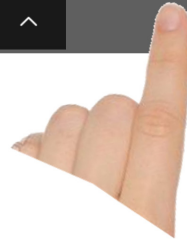
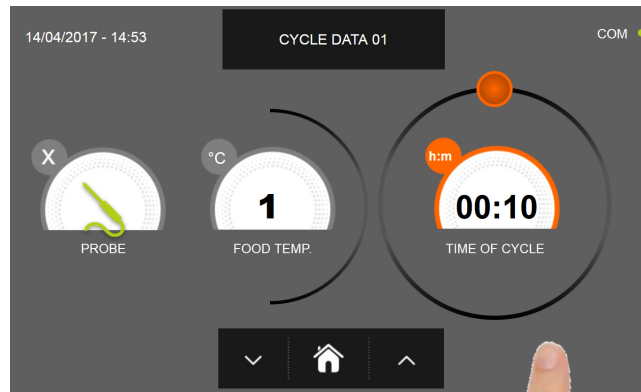

- Food temperature setting steps $\pm 1^{\circ}\text{C}$
- Cycle time setting steps ± 10 minuti

MULTI-PURPOSE BLAST CHILLER EVOLUTION



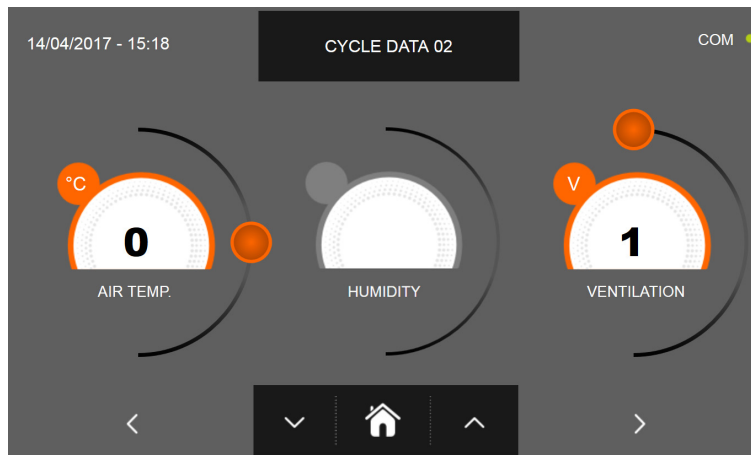

Press the icon  to proceed to the second programming page, press the icon  to go back to the previous page



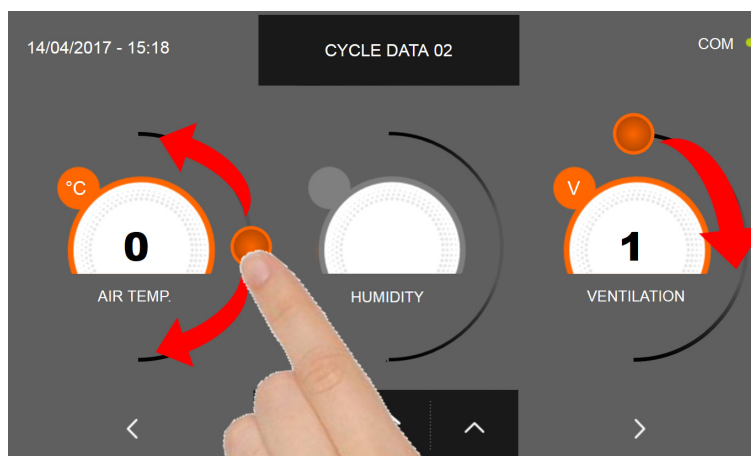

In the second programming page it is possible to set :
 Cell temperature
 Humidity (only for 1HUNDRED and cell temperatures > 0 ° C)
 Ventilation

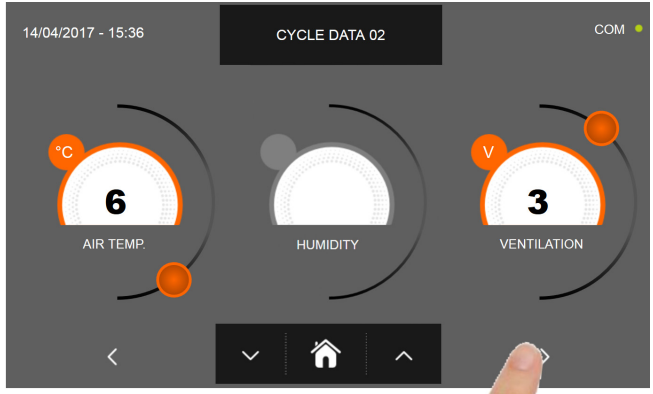

As per the values set in the first programming page, set the values by moving the cursor as indicated in the picture, or, after selecting the desired field, set the values with the icons  and 

MULTI-PURPOSE BLAST CHILLER EVOLUTION



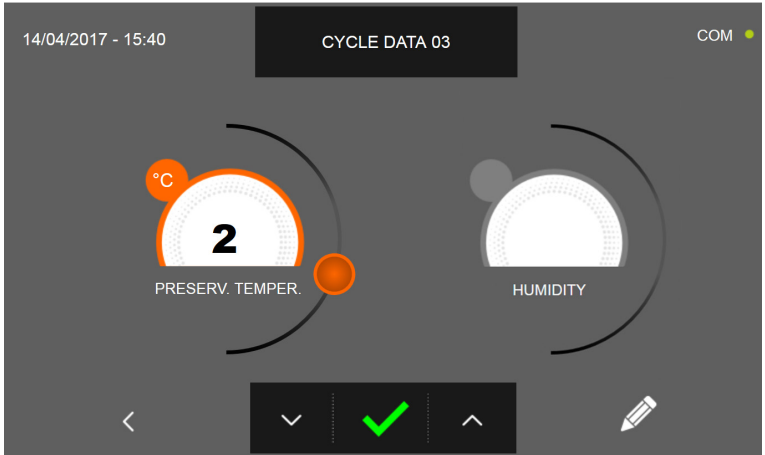

Press the icon  to proceed to the third programming page, press the icon  to go back to the previous page.



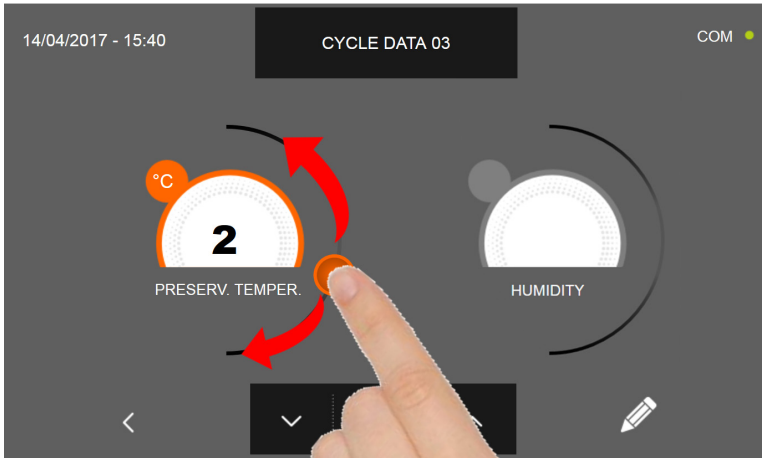

In the third programming page it is possible to set :
 Preservation temperature at the end of the cycle
 Humidity (only for 1HUNDRED and cell temperatures > 0 ° C)



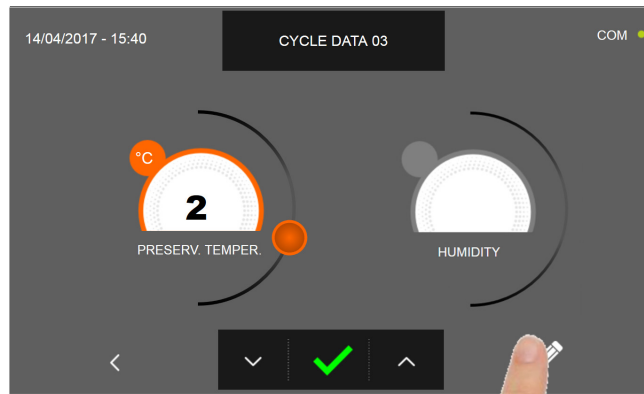

As per the values set in the first programming page, set the values by moving the cursor as indicated in the picture, or, after selecting the desired field, set the values with the icons  and 

MULTI-PURPOSE BLAST CHILLER EVOLUTION

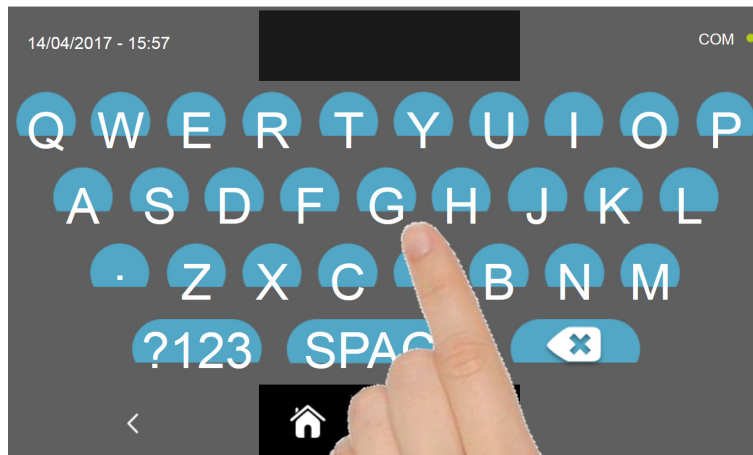

Press the icon  to record the name of a custom cycle and store it for future use.



With the keyboard enter the name of the cycle and then press the icon  to go back to the last programming page.

To delete the cycle just set, before starting the cycle itself, press the icon .

MULTI-PURPOSE BLAST CHILLER EVOLUTION

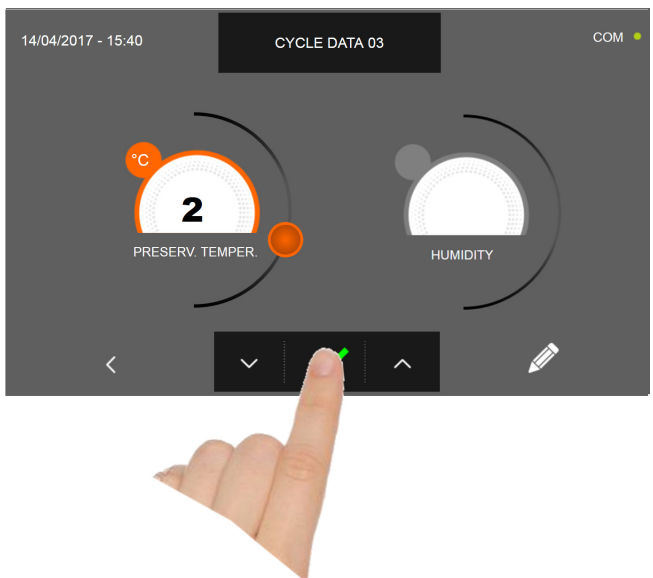

If a manual time cycle was chosen, after pressing the icon  the functioning data screen will be displayed. Refer to paragraph 15 - OPERATION CYCLES to display the temperature chart, input / output, parameter list or multilevel function. The cycle will end after the set time has elapsed. The end of the cycle is communicated with a buzzer that emits a sound. Press on the display to silence the buzzer. Alternatively, the buzzer automatically mutes after 60 seconds. Once the cycle is finished, the machinery will automatically enter the PRESERVATION mode

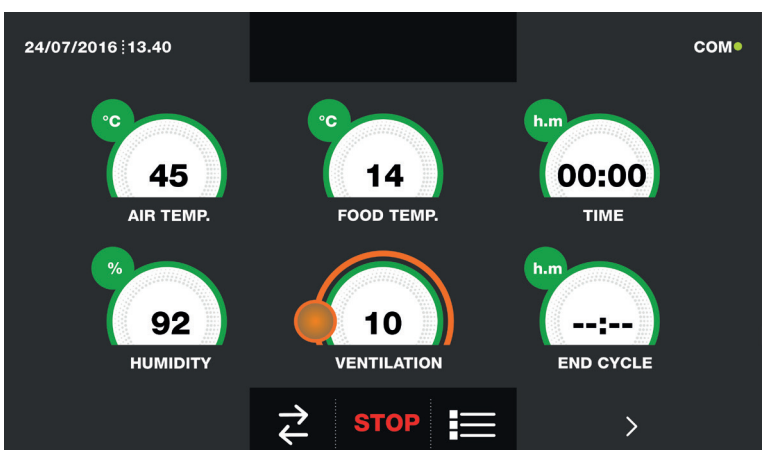

If otherwise the manual temperature cycle was chosen, after pressing the icon  you will be requested to place the food probe. Refer to paragraph 15 - OPERATION CYCLES to display the temperature chart, input / output, parameter list or multilevel function. During the cycle, by moving the cursor as shown in the figure, the ventilation value can be varied, with set 1 ÷ 10:



Once you have placed the food probe and after the machinery has correctly sensed the probe positioning, the cycle will start and the functioning screen will be displayed. The cycle will finish when the temperature at the core of the product will be higher or equal to the temperature set. The end of the cycle will be communicated with a buzzer that emits a sound. Press on the display to silence the buzzer. Alternatively, the buzzer automatically mutes after 60 seconds. Once the cycle is finished, the machinery will automatically enter the PRESERVATION mode.

We remind you that this phase can be maintained for a maximum recommended period of 24 hours.

16.18 - COMBY CYCLE

The multi-purpose blast chiller gives the possibility to manage combined functioning cycle, it is possible to program a sequence of blast chilling, thawing and proving cycles up to 6 different programming steps. With the machinery in STAND-BY mode, press the power icon as described in chapter 16.1. Once you have access to the HOME PAGE, proceed as follows:

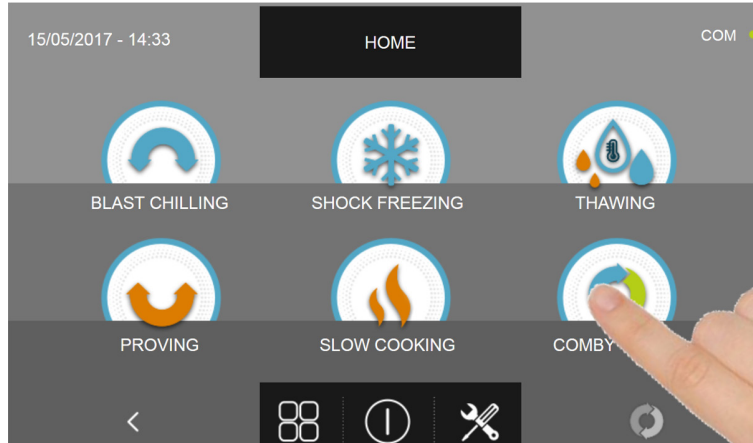

Press the COMBY icon to access its selection menu

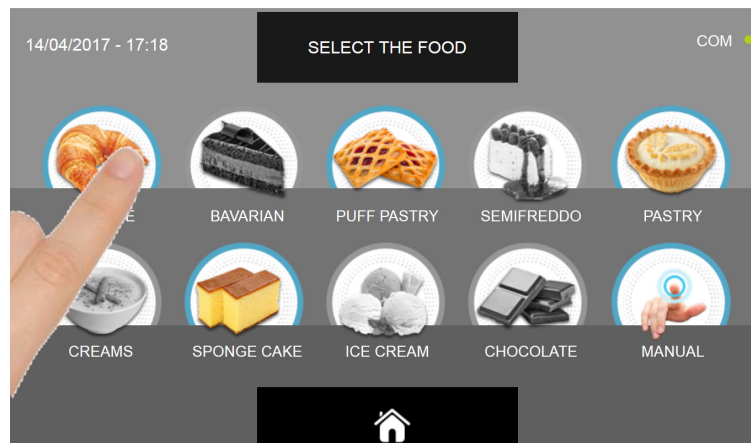

Select one of the food categories in the menu.

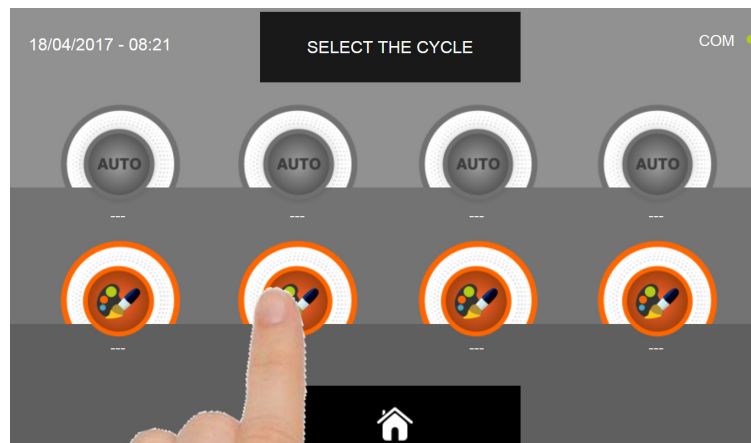



Select the setting icon of a CUSTOM cycle

N.B. THE AUTOMATIC CYCLES ARE NOT AVAILABLE

MULTI-PURPOSE BLAST CHILLER EVOLUTION

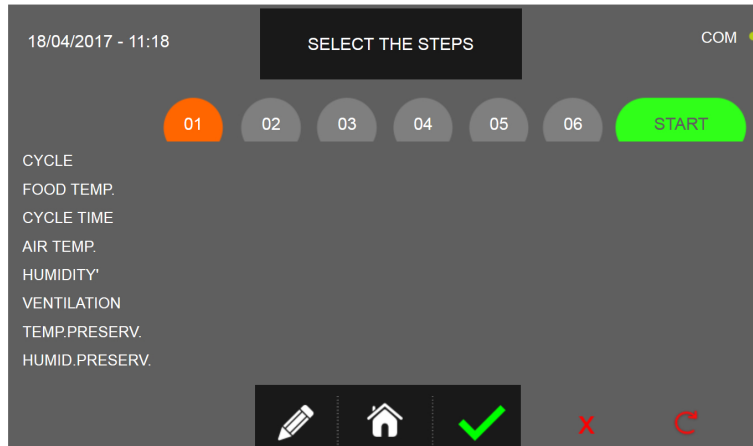
Once you have selected the custom cycle, the screen with the programming steps is displayed :



Press the icon  to record the name of a custom cycle and store it for future use.

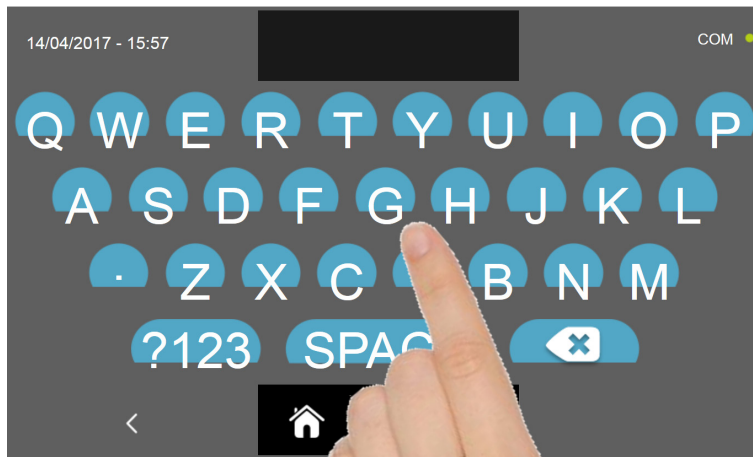

With the keyboard enter the name of the cycle and then press the icon  to go back to the last programming page.

To delete the cycle just set, before starting the cycle itself, press the icon .

At this point, in the HOME PAGE screen, the combined cycle icon will be gray and therefore not selectable

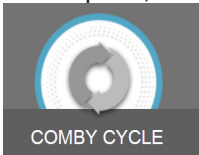

This situation indicates that the programming of the combined cycle is still in progress, so the selection of any cycle will be recorded in step 1 or subsequent.

To completely delete the settings made up to that point, press the icon  available in the HOME PAGE.

MULTI-PURPOSE BLAST CHILLER EVOLUTION

In order to select the different steps, proceed as follows :

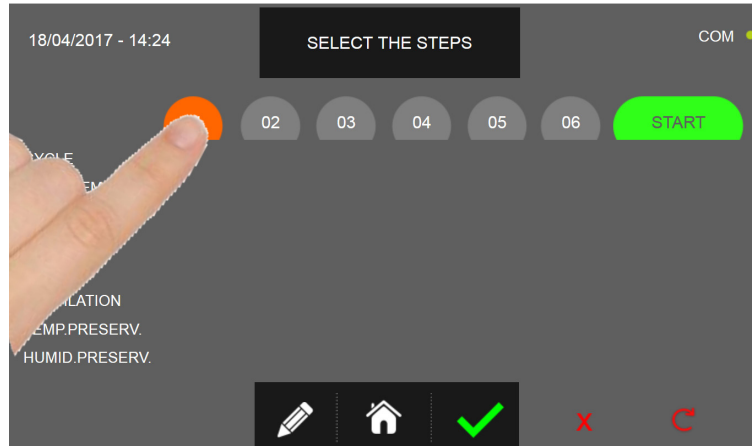

Select the cycle STEP you want to set

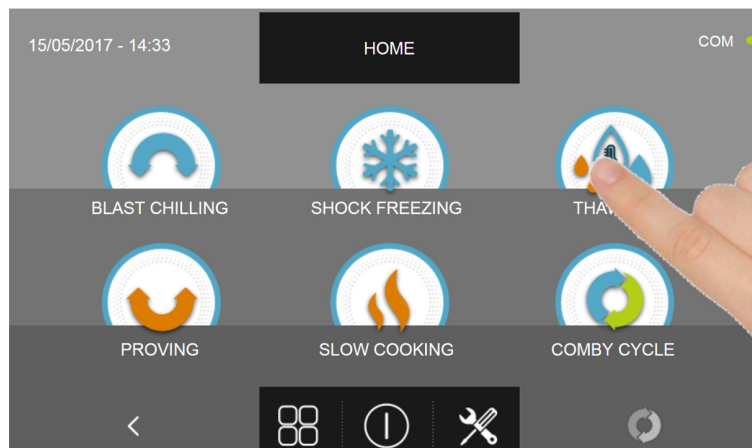

Select the cycle you want to perform : BLAST CHILLING - PROVING - THAWING



Depending on the chosen cycle and the initial choice of the type of food, there will be AUTOMATIC and / or CUSTOM cycles. Select the icon of the desired cycle.

If an AUTOMATIC cycle is chosen, proceed as explained in the chapters 16.4, 16.7, 16.10 e 16.16.

If a CUSTOM cycle is chosen, proceed as explained in the chapters 16.5, 16.8, 16.11, 16.13 e 16.16. If a MANUAL cycle is chosen, proceed as explained in the chapters 16.6, 16.9, 16.12, 16.14 e 16.17.

After programming STEP 1, select the next steps and repeat the selections of the various settings as explained for the STEP 1.

Set the conservation temperature value only for the last step of the combined cycle.

MULTI-PURPOSE BLAST CHILLER EVOLUTION

Once all the needed STEP are set, press the confirmation icon to start the cycle.



If the cycles require the use of the food probe, you will be required to insert it in the food.

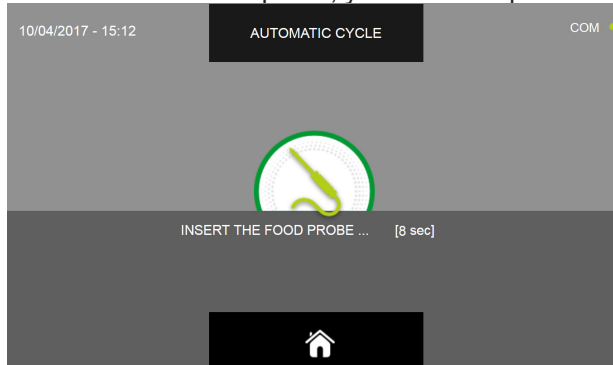

Once the probe insertion is detected, the cycle will begin

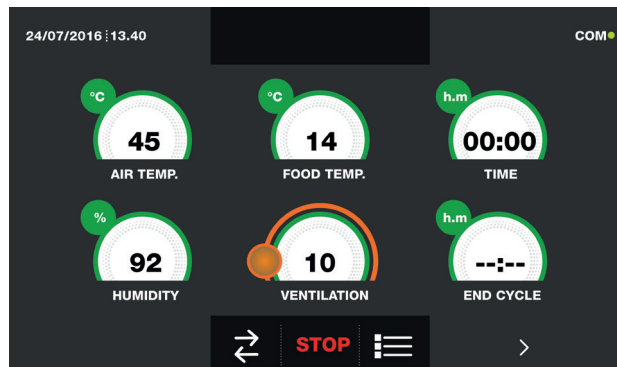

When the cycle begins, the screen with the functioning data is displayed.

Refer to paragraph 15 - OPERATION CYCLES to display the temperature chart, input / output, parameter list or multilevel function. During the cycle, by moving the cursor as shown in the figure, the ventilation value can be varied, with set 1÷10:

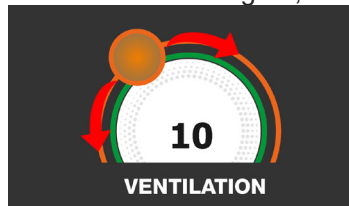

The COMBY cycle will finish only when the very last step ends and the end of the cycle will be communicated with a buzzer that emits a sound. Press on the display to silence the buzzer. Alternatively, the buzzer automatically mutes after 60 seconds.

Once the cycle is finished, the machinery will automatically enter the PRESERVATION mode with the settings that were programmed in the last STEP.

We remind you that this phase can be maintained for a maximum recommended period of 24 hours.

MULTI-PURPOSE BLAST CHILLER EVOLUTION

In case you want to delay the start of the cycle :

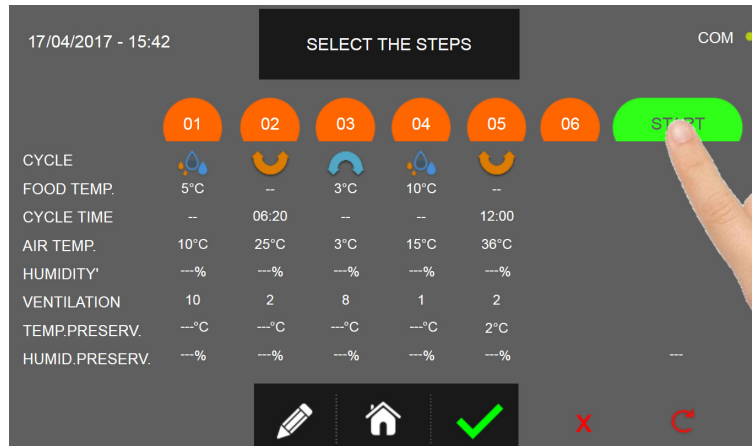



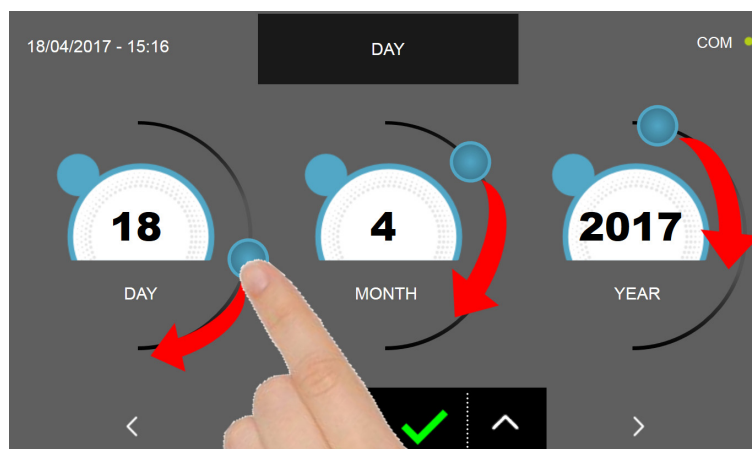

Press the icon START to access the data and time setting page

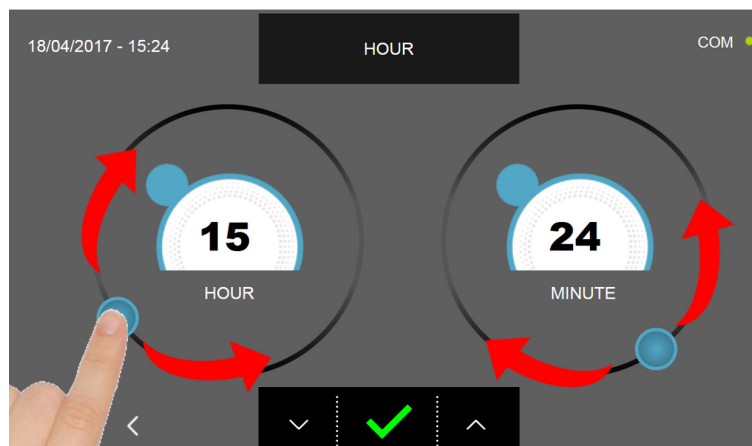

Set the values by moving the cursors or with the icons  and . Press the icon  to access the next programming page or press the icon  to go back to the previous page



Set the values by moving the cursors or with the icons  and . Press the icon  to confirm the settings just made, press the icon  to go back to the previous page and modify the set values.

MULTI-PURPOSE BLAST CHILLER EVOLUTION

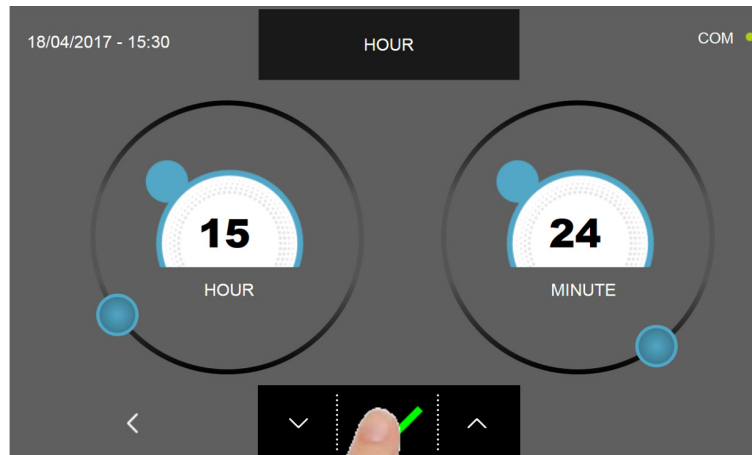

Press the confirmation button to set the date and time for the delayed start of the combined cycle. In the settings summary screen, the start date and time as well as the end date and time of the cycle are displayed.

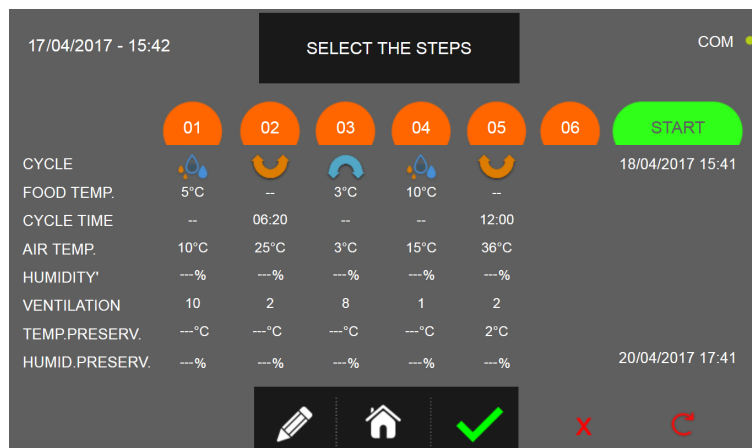

The cycle will begin at the programmed date and time.

It is anyhow possible to immediately start the cycle by pressing the icon



Press instead the icon



to erase all the setting programmed till now.

To cancel the delayed beginning of the cycle, press the icon



To modify the name set for a combined cycle, press the icon



and repeat the instruction given at the beginning of the chapter 16.18.

To go back to the HOME PAGE, press the icon



follow the instruction given at the beginning of chapter 16.18 to erase a cycle or proceed with setting the different STEP.

MULTI-PURPOSE BLAST CHILLER EVOLUTION

If the combined cycle is made only of TIME cycles, the software will automatically calculate the date and time at which the last step will end. Once the cycle is finished, the machinery will automatically enter the PRESERVATION mode with the settings that were programmed in the last STEP.

We remind you that this phase can be maintained for a maximum recommended period of 24 hours.

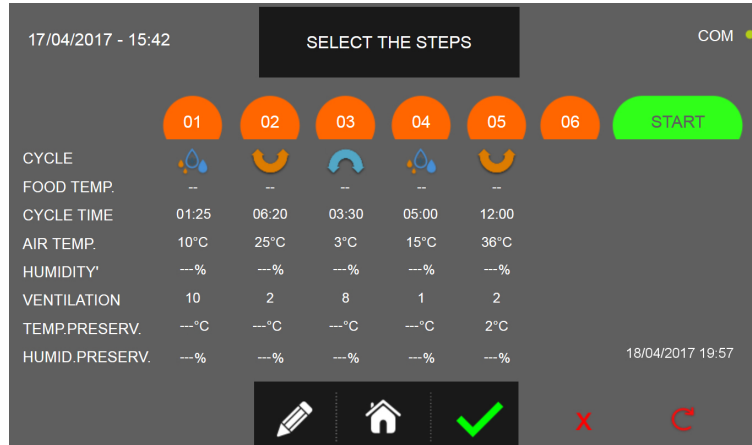

The last programmed step will end at the date and time as indicated in the lower right side of the display

EG. 18/04/2017 19:57

As anticipated, for this function it is necessary to set only personalized or manual cycles **by time**.

If one or more programmed steps are automatic or custom/manual cycles by temperature, the calculation will not be executed and instead of the date and time, the field will be null “---”.

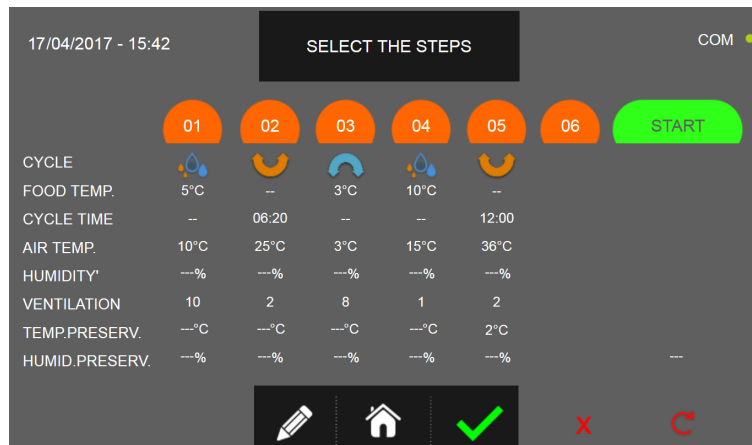

MULTI-PURPOSE BLAST CHILLER EVOLUTION

16.19 - MULTILEVEL FUNCTION

During the execution of a cycle, the MULTILEVEL function is available: for each tray it is possible to set a timer which will communicate the end of the cycle so the user will be advised by a buzzer when a specific tray needs to be removed from the machinery. The buzzer automatically mutes after 60 seconds or after the door has been opened to remove the tray. Remember that at the end of the last timer, the machine automatically will enter the PRESERVATION mode.

Start a BLAST CHILLING, PROVING or THAWING cycle as explained in the relative chapters.

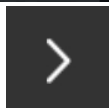
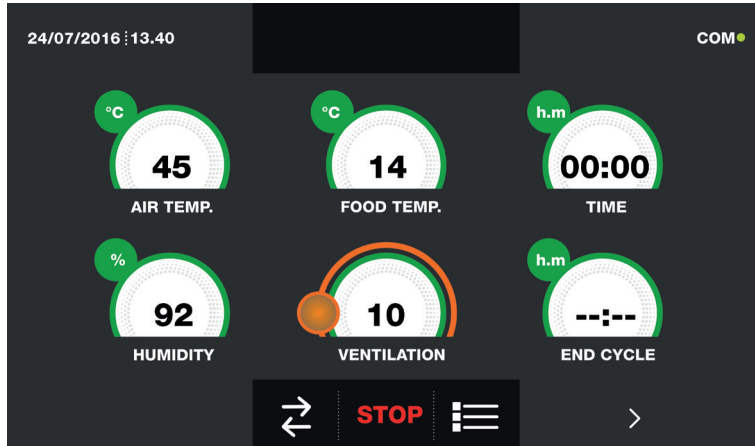

When the cycle is active, press the icon and access the page in which the chart with the product temperature and the cell temperature are displayed :

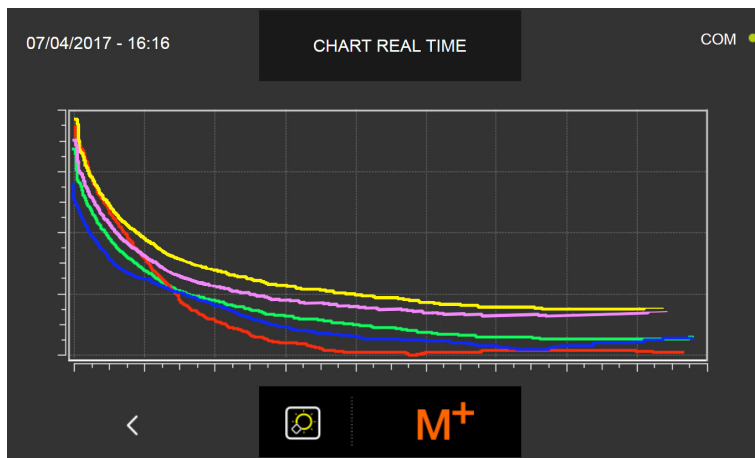

By pressing the icon the user is prompted access to the MULTILEVEL function setting page

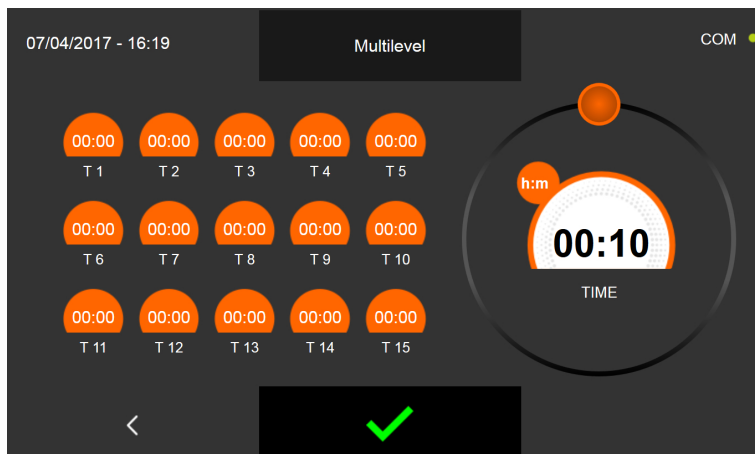

MULTI-PURPOSE BLAST CHILLER EVOLUTION

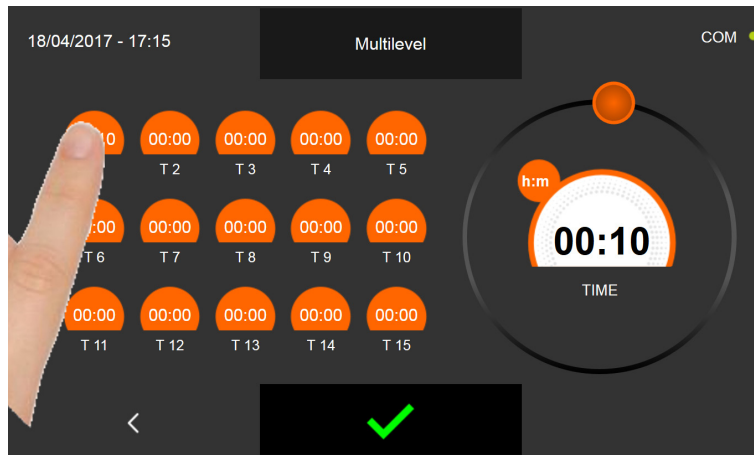

Select the tray for which you want to set the timer. The value in the orange box will flash

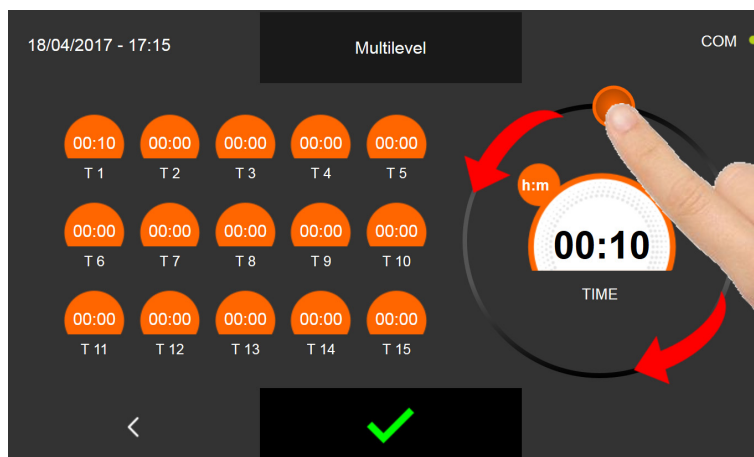

Adjust the cursor by moving it as shown in the image. Repeat this operation for all the trays that you want to remove before the end of the cycle. Press the icon  to confirm the settings.

When the time set for every single tray is elapsed, the buzzer will emit a sound, this sound is automatically interrupted after 60 seconds or by opening the door to remove the tray.

At the end of the last timer, the machine automatically will enter the PRESERVATION mode with the settings programmed at the beginning of the cycle.

We remind you that this phase can be maintained for a maximum recommended period of 24 hours.

MULTI-PURPOSE BLAST CHILLER EVOLUTION

16.20 - FUNCTIONS AVAILABLE DURING A CYCLE

When the machinery is performing a cycle, it is possible to access the following FUNCTIONS :

- I/O : Temperature probe, sensors status, inputs and outputs values
- Parameters : list with all the functioning parameters and their values
- Chart with the progression of the temperature probe and cell probe values

With an active cycle

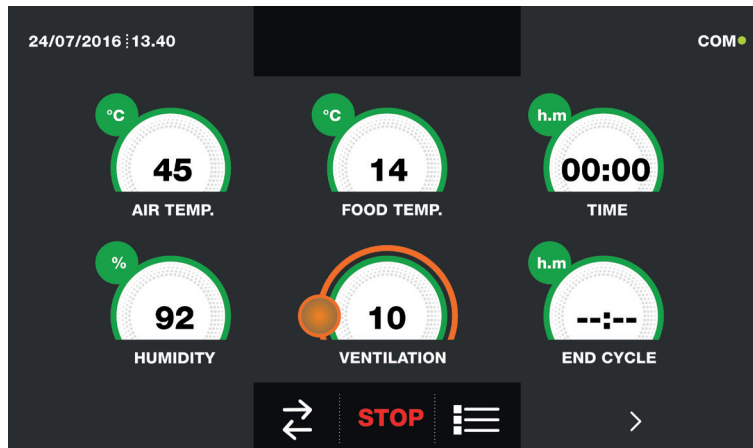

From the functioning data screen, by pressing the icon the user is prompted to the I/O screen :

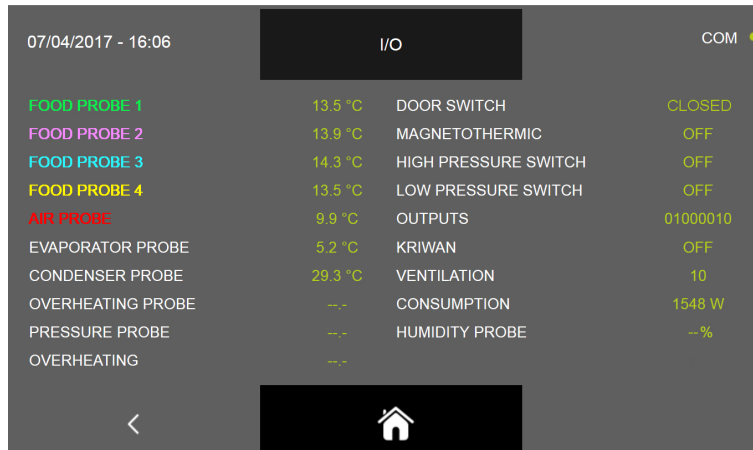

The available information are as follows:



Food probe 1	Point 1 temperature	Door switch	Sensor status Open/Closed
Food probe 2	Point 2 temperature	Magnetothermic	Switch status OFF/ON
Food probe 3	Point 3 temperature	High pressure switch	Pressure switch status OFF/ON
Food probe 4	Point 4 temperature	Low pressure switch	Pressure switch status OFF/ON
Air probe	Cell temperature	Outputs	Outputs status 1=Active 0=Not active
Evaporator probe	Evaporator temperature	Kriwan	Compressor protection status OFF/ON
Condenser probe	Condenser temperature	Ventilation	Evaporator fan speed 1-10
Overheating probe	VTE temperature (optional)	Consumption	Current power consumption
Pressure probe	VTE pressure (optional)	Humidity probe	Humidity probe value
Overheating	VTE temperature difference (optional)		

MULTI-PURPOSE BLAST CHILLER EVOLUTION

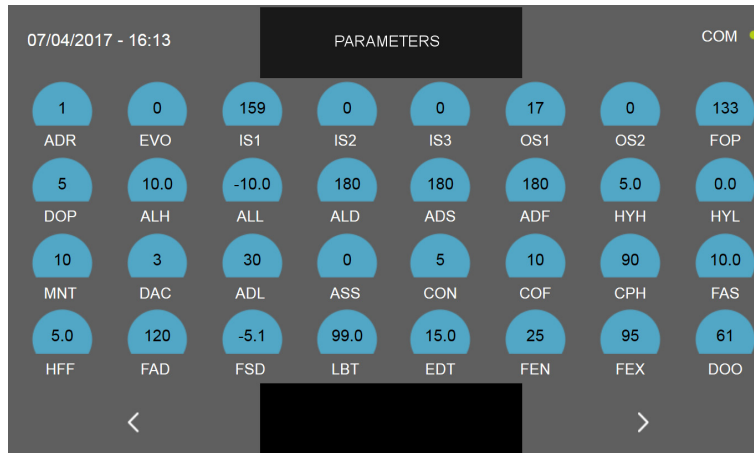

From the functioning data screen, by pressing the icon  you can access the functioning parameters screen (the parameters can not be modified in this page, but they serve as support as support for the after-sale technician who can analyze them and see if during a cycle some alarms or malfunctions are occurring) :



Press the icon  to access the next programming page or press the icon  to go back to the previous page or to the page with the active cycle information.

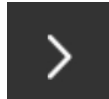

From the functioning data screen, by pressing the icon  you can access the chart which shows the progression of the temperature detected by the food probe and by the air probe:

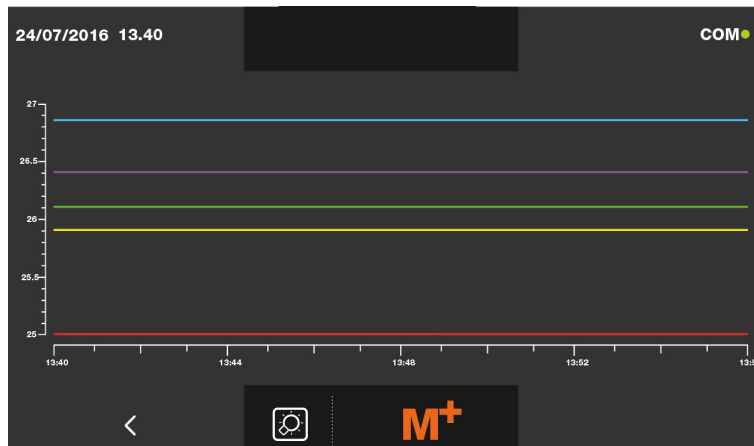

Green	Food probe point 1 temperature
Violet	Food probe point 2 temperature
Light blue	Food probe point 3 temperature
Yellow	Food probe point 4 temperature
Red	Air probe temperature

By pressing the icon  you can access the MULTILEVEL function setting page as described in chapter 16.19.



By pressing the icon  it is possible to switch on the light bar inside the cell (optional) to see the food placed in.



The icon, if the optional is activated, will be colored in yellow  , otherwise, if not active, will be plain white .



MULTI-PURPOSE BLAST CHILLER EVOLUTION

With the comby cycle in progress, it is possible to view a summary page of all the programmed phases:

Start a cycle as explained in the relevant chapters.

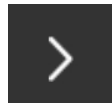
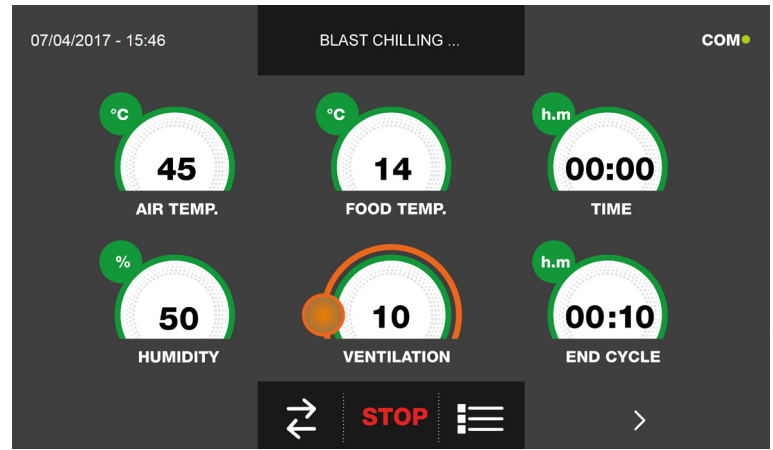

With the cycle active, press the icon and access the screen with the temperature chart for the food probe and the air probe :

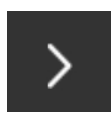
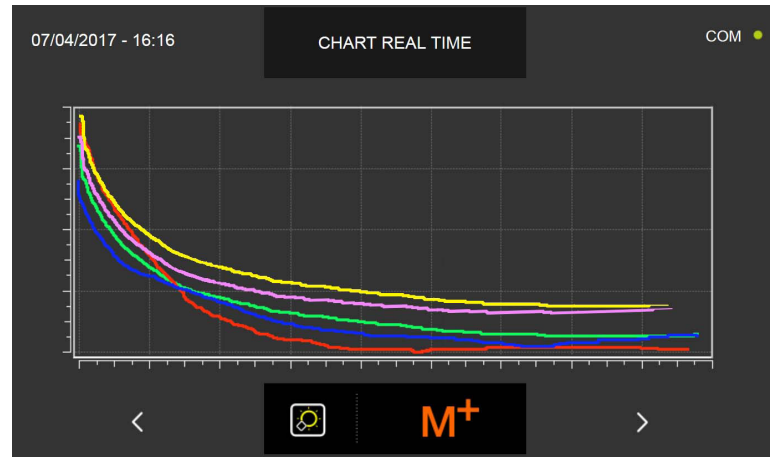

Press again the icon and access the summary page :

	01	02	03	04	05	06	START
CYCLE							
FOOD TEMP.	5°C	--	3°C	10°C	--		
CYCLE TIME	--	08:20	--	--	12:00		
AIR TEMP.	10°C	25°C	3°C	15°C	36°C		
HUMIDITY*	--%	--%	--%	--%	--%		
VENTILATION	10	2	8	1	2		
TEMP.PRESERV.	--°C	--°C	--°C	--°C	2°C		
HUMID.PRESERV.	--%	--%	--%	--%	--%		

Highlighted in green the phase in progress. In the above example is phase 01.

By pressing the pencil icon instead, it is possible to save the name of the combined cycle if it had not been done previously.



16.21 - 1HUNDRED - HUMIDITY MANAGEMENT AND 100°C SLOW COOKING

The machinery defined as 1HUNDRED has the possibility of managing the humidity value inside the cell from 15% to 95%, in addition, the slow cooking cycle provides for the maximum temperature in the cell of 100°C and 90°C for the food. The humidity is created through a boiler that emits steam into the cell, while the extraction takes place via a fan placed above the machinery.

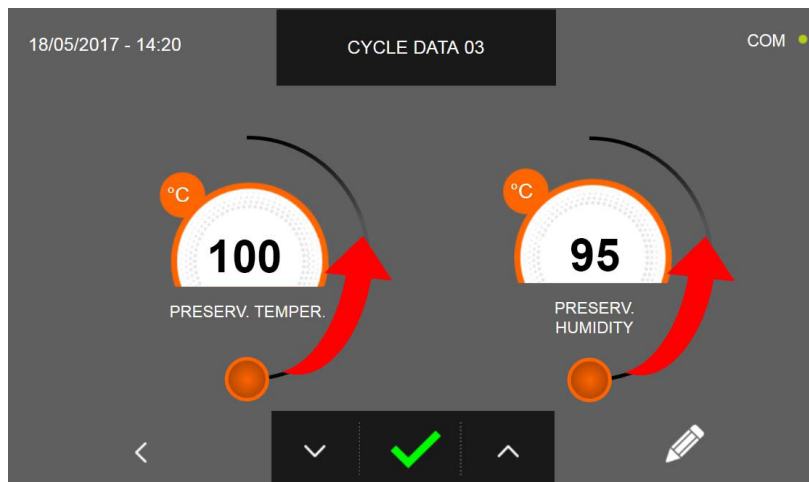
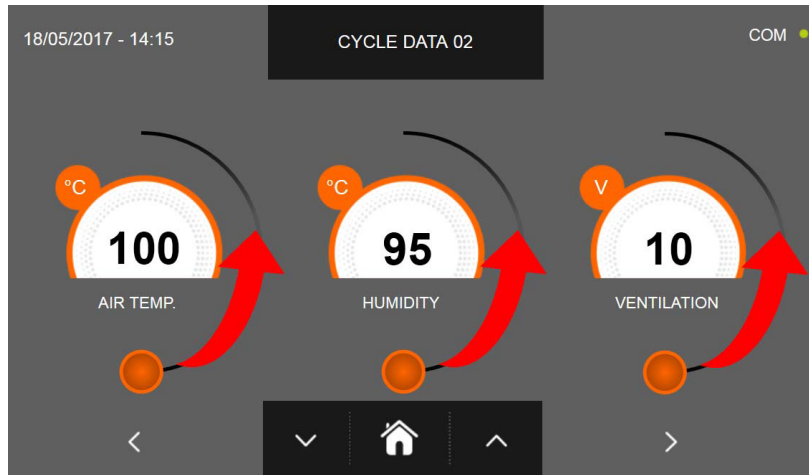
Below is an example of the second and third programming pages where it is explained how to adjust the humidity. The regulation for the temperatures remains the same as explained in the previous chapters



As for the values set in the programming page, adjust the values by moving the sliders as indicated

in the figure, or select the desired field and set the values using the icons  and 

As for all the cycles treated in the previous chapters, also in this case, the end of the cycle is communicated with a buzzer that emits a sound. Press on the display to silence the buzzer. Alternatively, the buzzer automatically silences after 60 seconds. Once the cycle is finished, the machine enters PRESERVATION mode.

Please note that the preservation phase can be maintained for a maximum suggested duration of 24 hours.







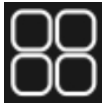
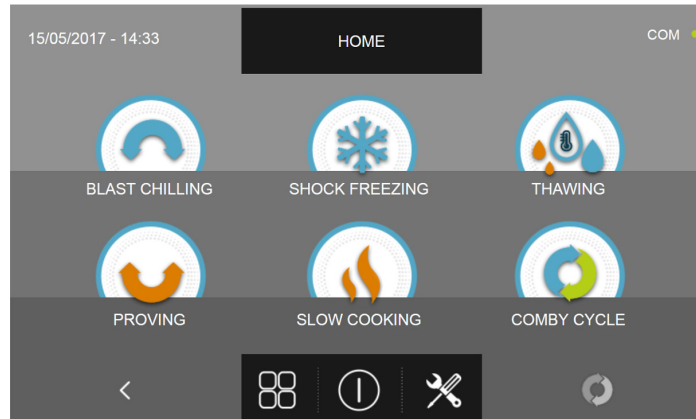

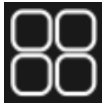

Options

17 - OPTION MENU

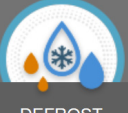
From the HOME PAGE it is possible to access the option menu

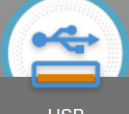

Press the icon  to access the screen with the following functions :

 EXTRACTION	EXTRACTION : to start the food probe heating function (Only models equipped with the heated probe)	 HELP	HELP : to display the videos that aid in the use of the machine
 HACCP	HACCP : to display the log of the performed cycles	 LANGUAGE	LANGUAGE : to set the display language
 ALARMS	ALARMS : to display the alarm list	 DEFROST	DEFROST : to start a defrosting automatic cycle
 INFO	INFO : to display the information about the machinery	 I/O	I/O : to access the list of Input and Output with the values/status
 STERILIZATION	STERILIZATION : to start a sterilization cycle (Only models equipped with the sterilizer)	 TIME	TIME : to set the date and time
 USB	USB : to download the HACCP and SETUP file, import new SETUP file and update the firmware	 PASSWORD	PASSWORD : to set the access and programming password

MULTI-PURPOSE BLAST CHILLER EVOLUTION

17.1 - EXTRACTION

This menu allows to start the food probe heating function. This is an optional function and is intended for the use in combination only with the optional heated probe which has in its inside a resistor that heats up the probe body and ease the extraction of the probe itself from food preferably frozen.

If in the display the EXTRACTION icon is gray, the function is not available, not installed or not activated.



From the HOME PAGE, press the icon  to access the Option menu.

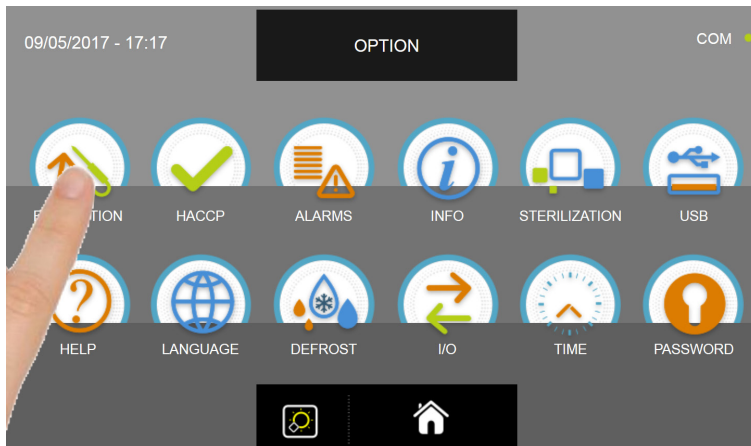
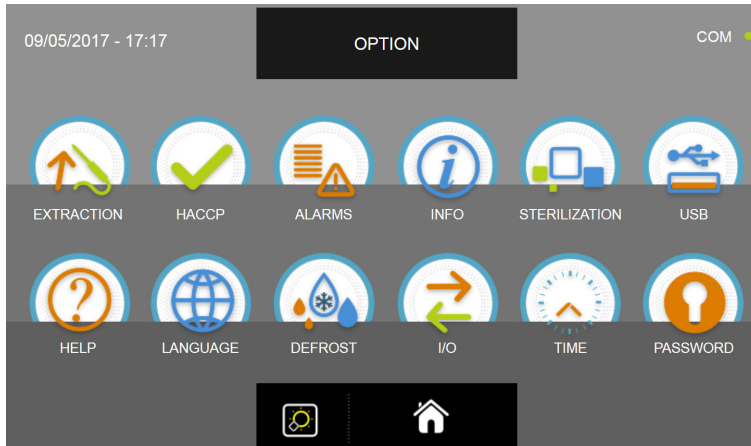

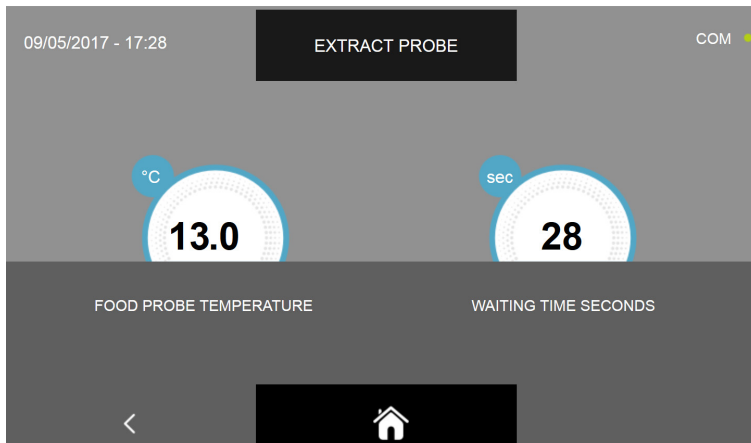

From the OPTION menu, press the EXTRACTION icon to start the food probe heating function



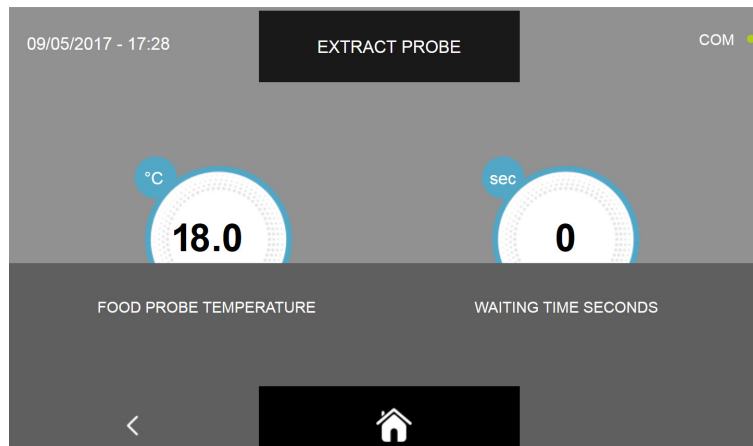

The extraction function has a pre-set duration of 30 seconds. Wait till the end of the timer to extract the probe.

MULTI-PURPOSE BLAST CHILLER EVOLUTION



When the function is finished, meaning when the timer indicates 0 seconds, press the icon  to go back to the previous option selection page or press the icon  to go back to the HOME .

It is possible to stop the execution of the probe heating function in any moment by pressing either the icon  or , with the effects described above.

MULTI-PURPOSE BLAST CHILLER EVOLUTION

17.2 - HACCP

This menu allows to display the completed cycles and the possibility also to visualize the chart with the temperature progression

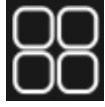

From the HOME PAGE, press the icon  to access the Option menu.

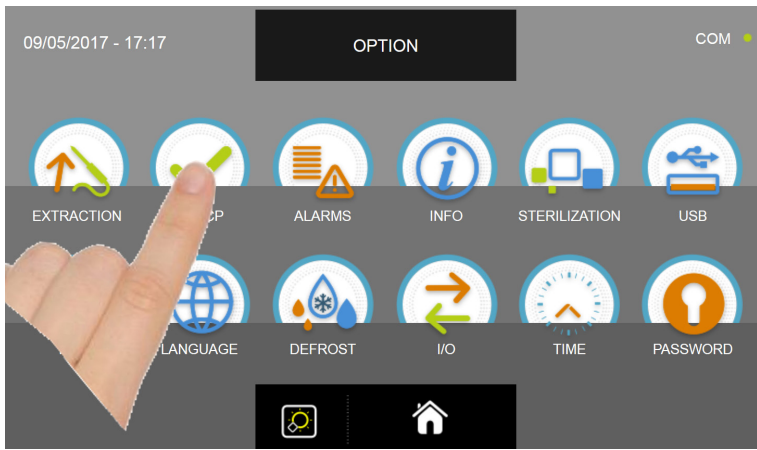
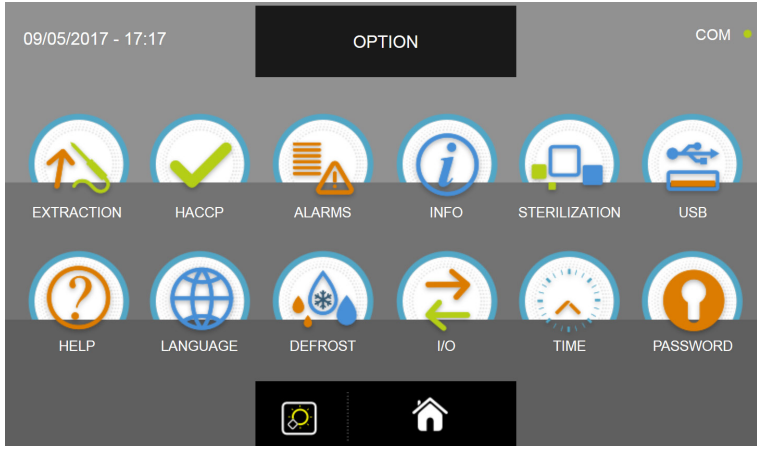

From the OPTION menu, press the HACCP icon to access the cycle list

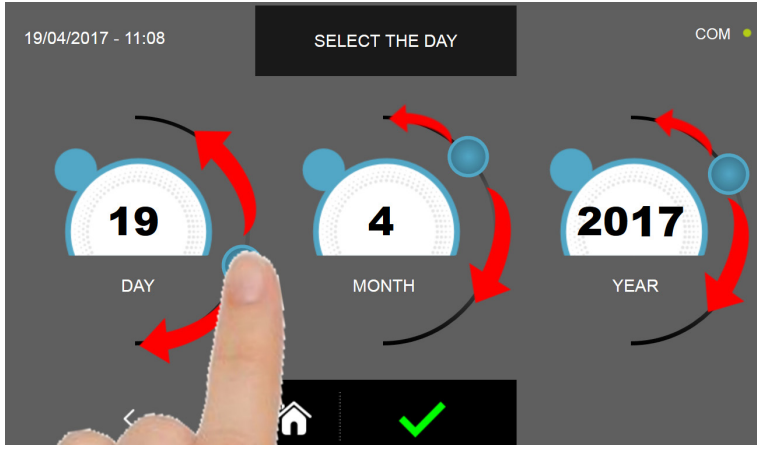

Set the cursors as shown in the above picture to select the reference date for the completed cycles

Press the icon  to confirm the choice and display the performed cycle list.

MULTI-PURPOSE BLAST CHILLER EVOLUTION

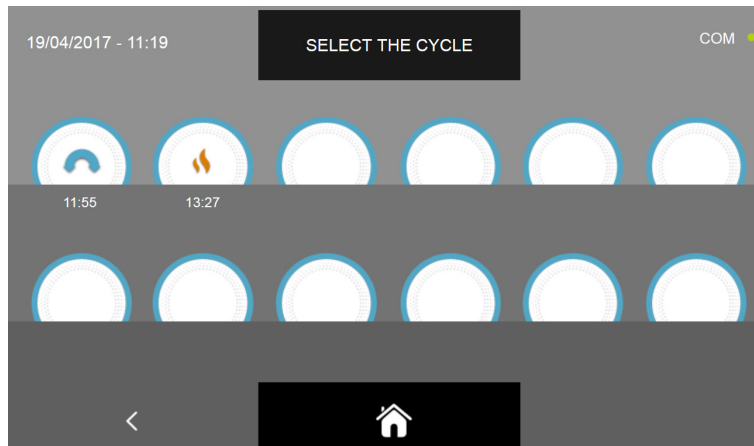

The list of performed cycle is displayed with the time the cycle was concluded

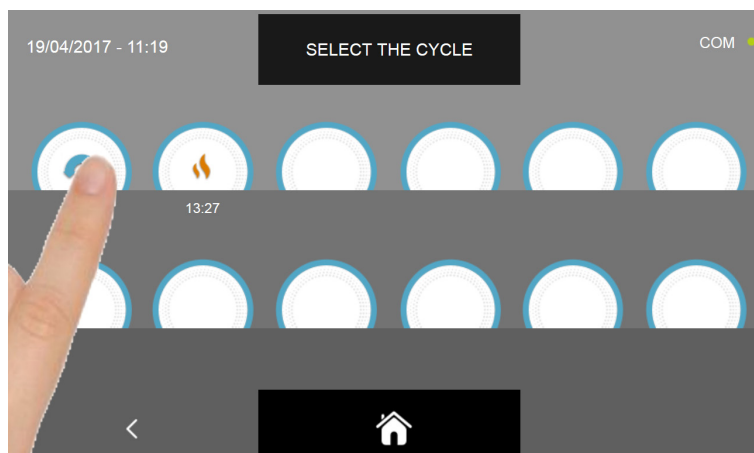

Select the icon corresponding to the cycle to be displayed

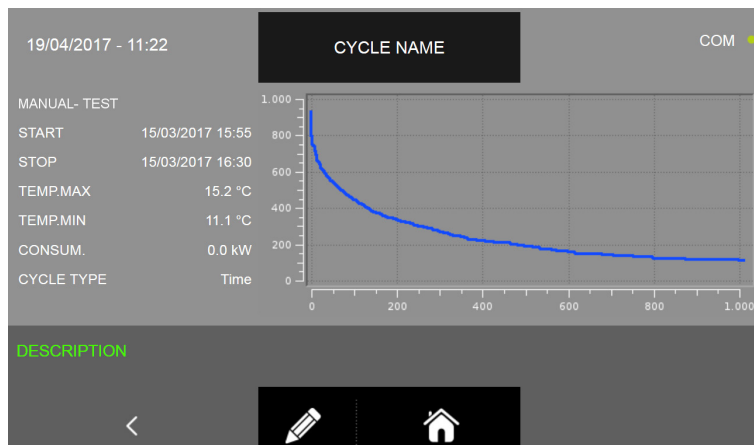

The display will show the following information:

Cycle type (Food family name or Manual) - food category or custom name

(the custom name will be displayed if it was set as explained in the chapters 16.5 - 16.6 - 16.8 -16.9 - 16.11 - 16.12 - 16.13 - 16.14 - 16.16 - 16.17 ; if it was not set, the the food category will be followed by " --- "; see the given example at page 112)

Date and time when the cycle began

Date and time when the cycle ended

Maximum temperature

Minimum temperature

Total power consumption

Type of cycle performed (by time or by temperature)

Chart with the progression of the temperature over time

MULTI-PURPOSE BLAST CHILLER EVOLUTION

In addition to the cycle name that can be recorded during the cycle programming phases, it is possible to set a maximum of 20 characters to describe the performed cycle .

Press the icon  to set a description about the performed cycle

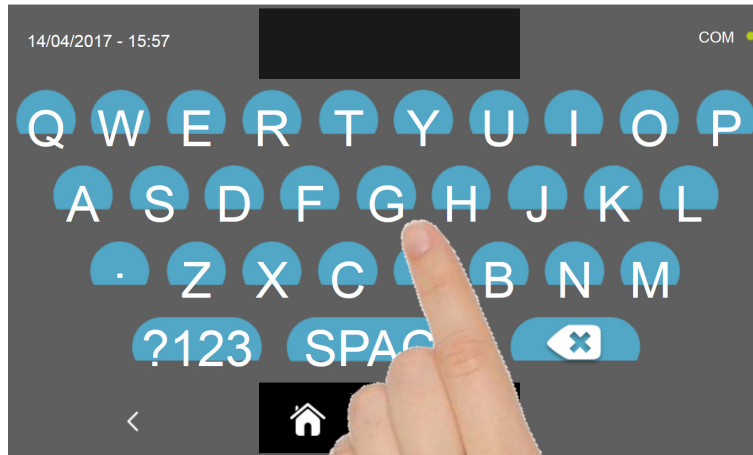

Insert the description using the keyboard and confirm it with the icon 

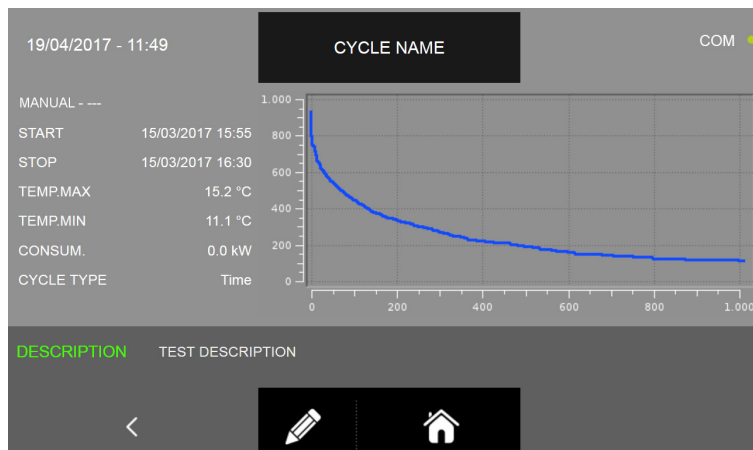

Press the icon  to go back to the previous page in which the performed cycle can be selected or press the icon

 to go back to the HOME PAGE.

17.3 - ALARMS

This menu allows to display the list of the recorded alarms



From the HOME PAGE, press the icon  to access the Option menu.

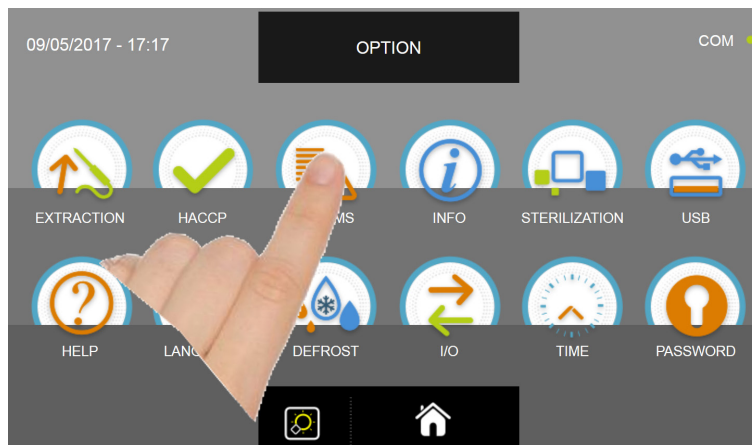
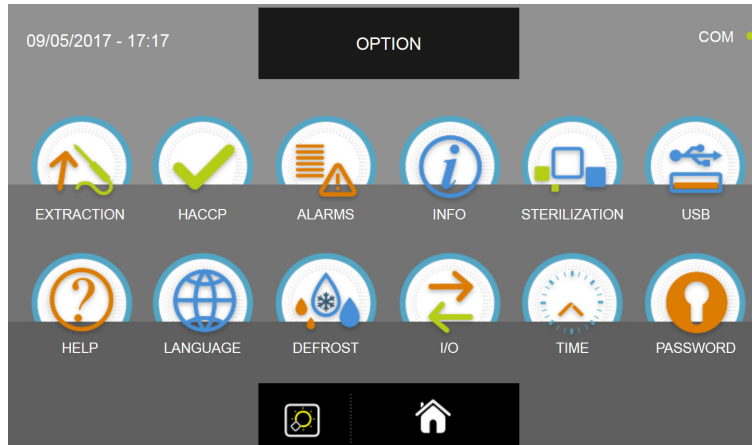

From the OPTION menu, press the icon ALARMS to access the list

ALARM TYPE	START	TIME	TEMP.
ALARM 1	01/02/2017	00:00	
ALARM 2	01/02/2017	00:00	
ALARM 3	01/02/2017	00:00	
ALARM 4	01/02/2017	00:00	
ALARM 5	01/02/2017	00:00	
ALARM 6	01/02/2017	00:00	
ALARM 3	01/02/2017	00:00	
ALARM 1	01/02/2017	00:00	

The list provides the following information:

Alarm description

Date and time when the alarm occurred

Alarm duration

Maximum temperature reached in the cell during the alarm

For the complete list of the ALARMS and their description, see the TROUBLESHOOTING chapter.

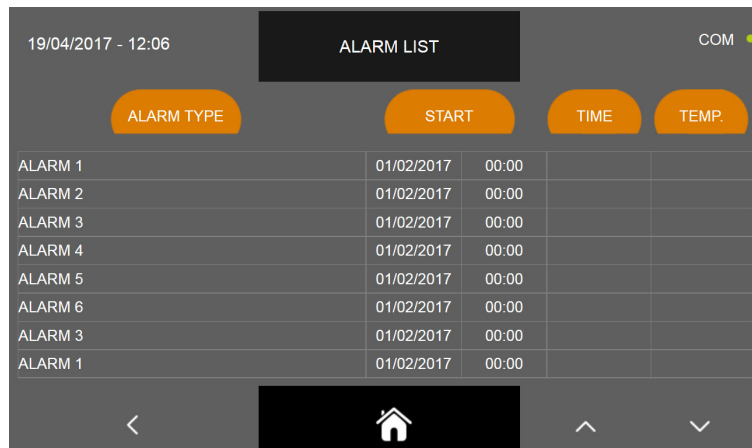

MULTI-PURPOSE BLAST CHILLER EVOLUTION





19/04/2017 - 12:06 ALARM LIST COM ●

ALARM TYPE	START	TIME	TEMP.
ALARM 1	01/02/2017	00:00	
ALARM 2	01/02/2017	00:00	
ALARM 3	01/02/2017	00:00	
ALARM 4	01/02/2017	00:00	
ALARM 5	01/02/2017	00:00	
ALARM 6	01/02/2017	00:00	
ALARM 3	01/02/2017	00:00	
ALARM 1	01/02/2017	00:00	

Navigation icons: < Home ^ v

Press the icons  and/or  to scroll the list in the additional pages if present.

Press the icon  to go back to the previous option selection page or press the icon  to go back to the HOME PAGE.

MULTI-PURPOSE BLAST CHILLER EVOLUTION

17.4 - INFO

This menu allows to display the information about the machinery.



From the HOME PAGE, press the icon  to access the Option menu.

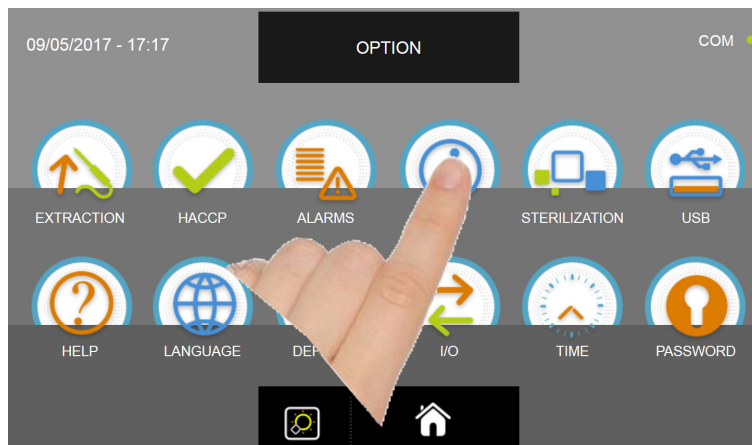
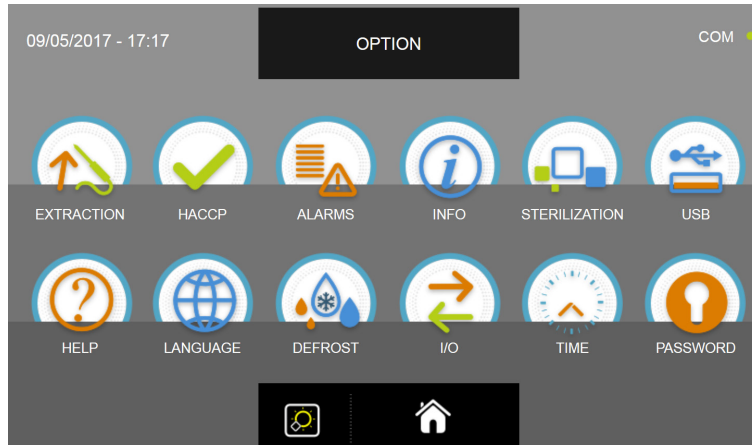

From the OPTION menu, press the INFO icon to access the list





The provided information are as follows :

ID PRODUCT	unique code of the display	IP ADDRESS	machine IP address
SOFTWARE RELEASE	display software version	SUBNET	subnet address
FIRMWARE RELEASE	controller firmware version	GATEWAY	gateway address
SERIAL NUMBER	machine serial number	DNS	DNS address
ID WIRELESS	wireless probe code, if any	MAC ADDRESS	display unique address

The SET and DHCP keys, like all the data in the right column, relate to any EVOCLOUD connection.

MULTI-PURPOSE BLAST CHILLER EVOLUTION





Press the icon  to go back to the previous option selection page or press the icon  to go back to the HOME.

17.5 - STERILIZATION

This menu allows to start a sterilization cycle, please note that the cycle is optional and requires the installation of the sterilization kit to be connected to the machinery.

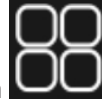
If in the display the STERILIZATION icon is gray, the function is not available, not installed or not activated.



From the HOME PAGE, press the icon  to access the Option menu.

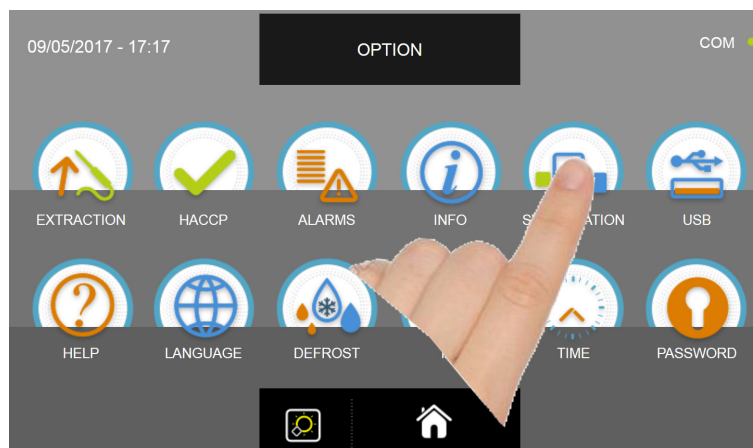
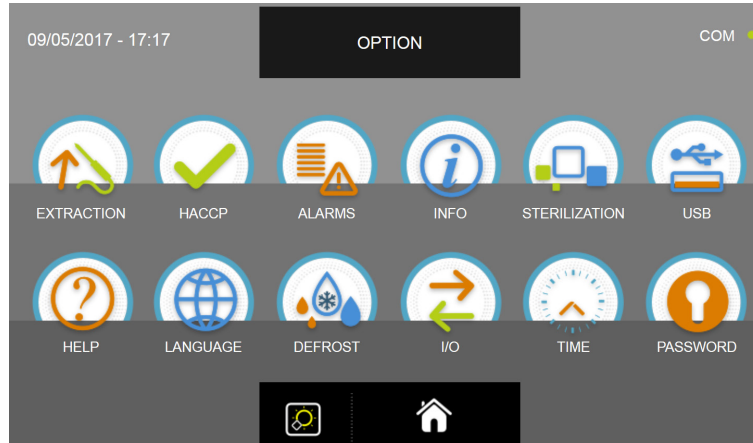

From the OPTION menu, press the STERILIZATION icon to start the cycle

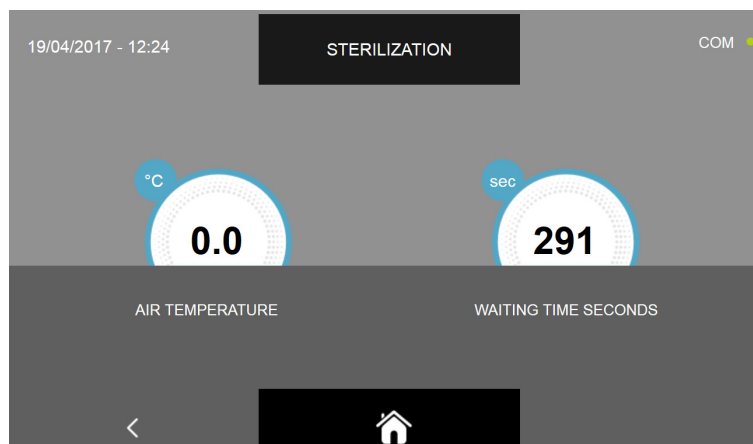



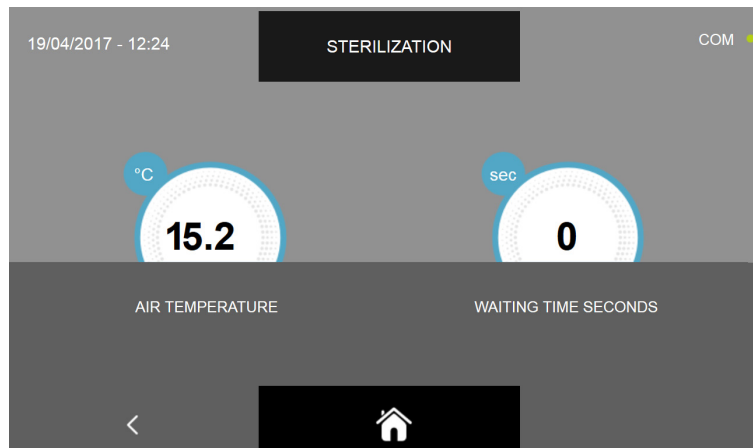

The sterilization cycle is a manual cycle with a preset duration of 300 seconds

PLEASE NOTE THAT IT IS STRONGLY RECOMMENDED NOT TO PERFORM A STERILIZATION CYCLE WHEN ANY TYPE OF FOOD IS PRESENT IN THE CELL AS THIS WILL UNDERMINE THE FOOD ITSELF.

MULTI-PURPOSE BLAST CHILLER EVOLUTION



When the cycle is finished, meaning when the timer indicates 0 seconds, press the icon  to go back to the previous option selection page or press the icon  to go back to the HOME .

It is possible to stop the execution of the sterilization manual cycle in any moment by pressing either the icon  or , with the effects described above.

MULTI-PURPOSE BLAST CHILLER EVOLUTION

17.6 - USB

This menu allows to export the HACCP data, export and import the cycles SETUP and to update both the firmware of the display and the main power electronic board.



From the HOME PAGE, press the icon  to access the Option menu.

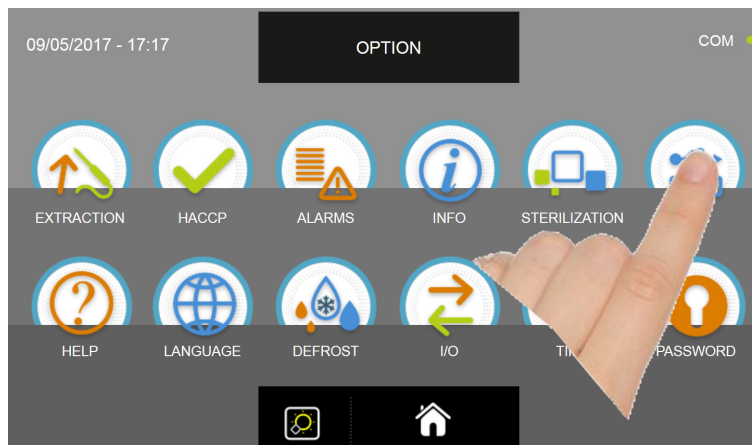
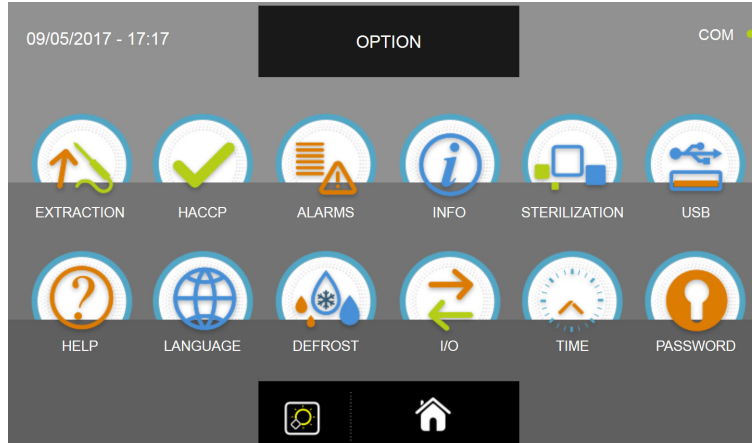

From the OPTION menu, press the USB icon to access its functions

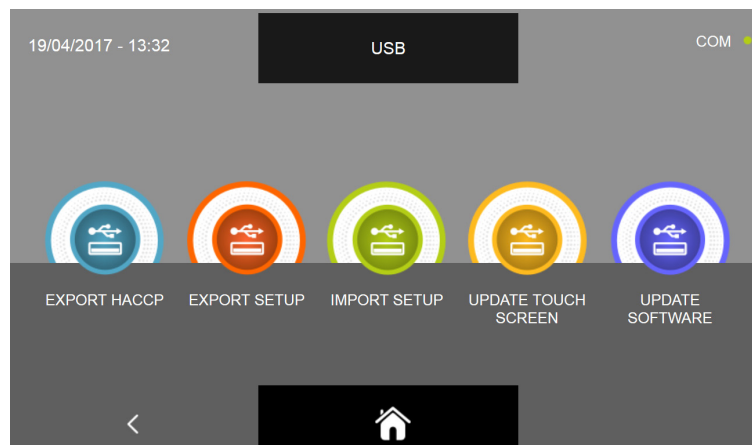

The functions available are as follows :

- EXPORT HACCP
- EXPORT SETUP
- IMPORT SETUP
- UPDATE TOUCH SCREEN
- UPDATE SOFTWARE

MULTI-PURPOSE BLAST CHILLER EVOLUTION

17.6.1 - EXPORT HACCP

N.B. FOR THIS FUNCTION IT IS NECESSARY TO INSERT A USB PEN DRIVE FORMATTED WITH FAT32 FILE SYSTEM, EMPTY, WITHOUT ANY PREVIOUS STORED DATA INSIDE



From the USB sub menu, press the EXPORT HACCP icon

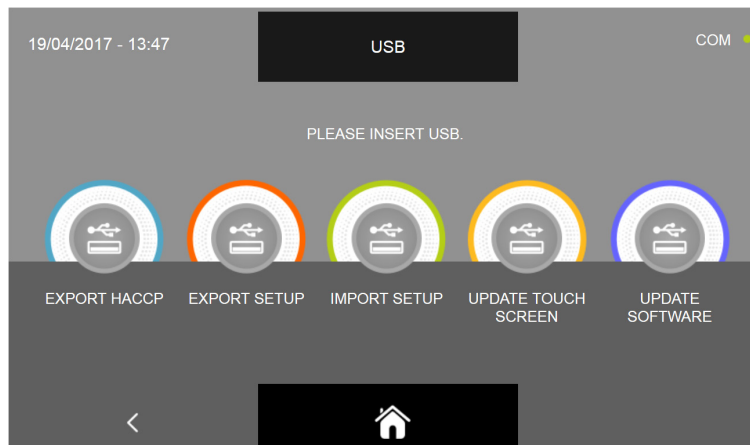

It is required to insert the pen drive into the appropriate panel connector

Open the protection cap of the USB connector and insert the pen drive.



MULTI-PURPOSE BLAST CHILLER EVOLUTION

When the insertion of the pen drive is detected, the download will automatically start and finish.

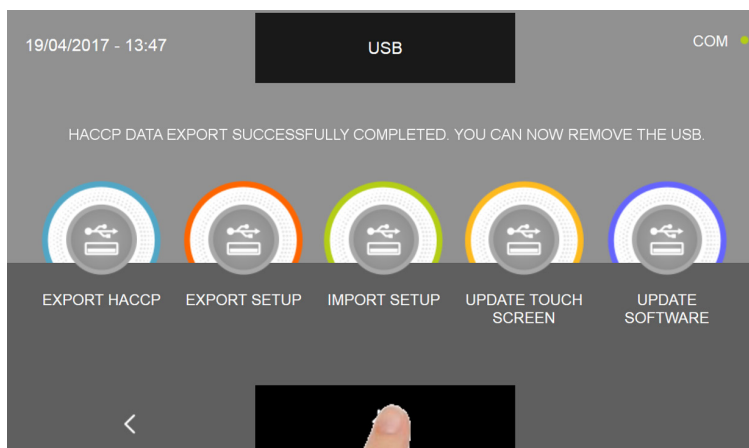

Press the icon  to go back to the HOME PAGE and only then, remove the pen drive.

The saved file is a compressed archive named HACCP.zip. Once you extract the archive, you will have a list of *.CSV file which can be opened in EXCEL. Without extracting the archive, it is possible to display the charts of the performed cycles by using the optional TRACER program.

The name of the file contains the following informations : DATE (year, month, day), TIME (hours, minutes) and type of performed cycle, eg.: 1704190817P_4_ABB.csv:

i.e.: **year** = 2017 **month** = 04 **day** = 19 **hour** = 08 **minute** = 17

cycle type = P (P= probe / T= time) _ 4 (progressive cycle number) _ ABB (ABB = blast chilling, LIE = proving, CON= preservation, SCO=thawing, SUR=shock freezing, COT=slow cooking)

The file data are stored in columns and recorded every 10 seconds :

Day/month/year/hour/ minute/seconds	Probe point 1	Probe point 2	Probe point 3	Probe point 4	Air Probe	Alarm presence 1=Yes, 0= No	Power consumption	Product core point
190417081820	26.5	27.7	28.5	27.6	21.2	1	1200	3
190417081830	26.1	27.0	27.8	27.4	21.1	1	0	3

If the machinery is used approximately for 6 hours per day, the internal memory will be depleted over 1 year after which, the most recent data will take the place of the older ones (FIFO transit method). The occupied memory space depends on the number and duration of the performed cycles.

MULTI-PURPOSE BLAST CHILLER EVOLUTION

17.6.2 - EXPORT SETUP

N.B. FOR THIS FUNCTION IT IS NECESSARY TO INSERT A USB PEN DRIVE FORMATTED WITH FAT32 FILE SYSTEM, EMPTY, WITHOUT ANY PREVIOUS STORED DATA INSIDE

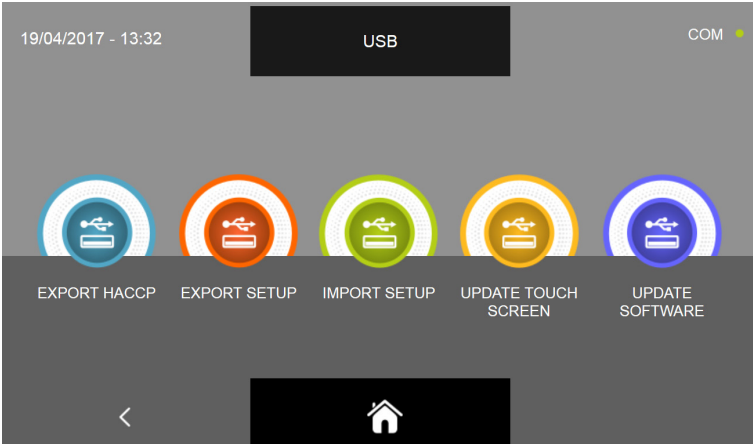

From the USB sub menu, press the EXPORT SETUP icon

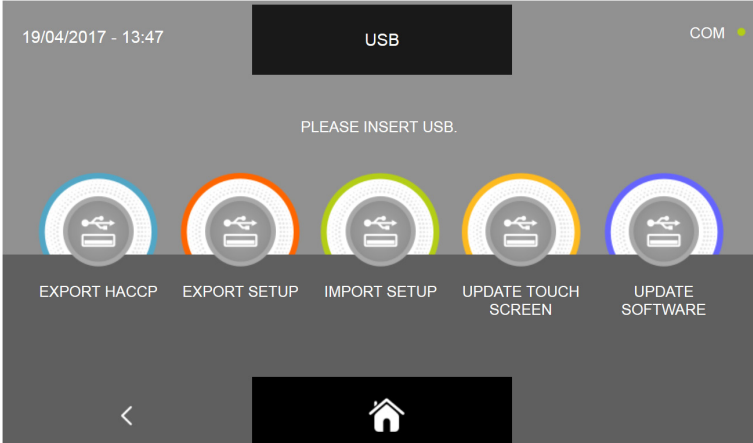

It is required to insert the pen drive into the appropriate panel connector

Open the protection cap of the USB connector and insert the pen drive.



MULTI-PURPOSE BLAST CHILLER EVOLUTION

When the insertion of the pen drive is detected, the download will automatically start and finish.

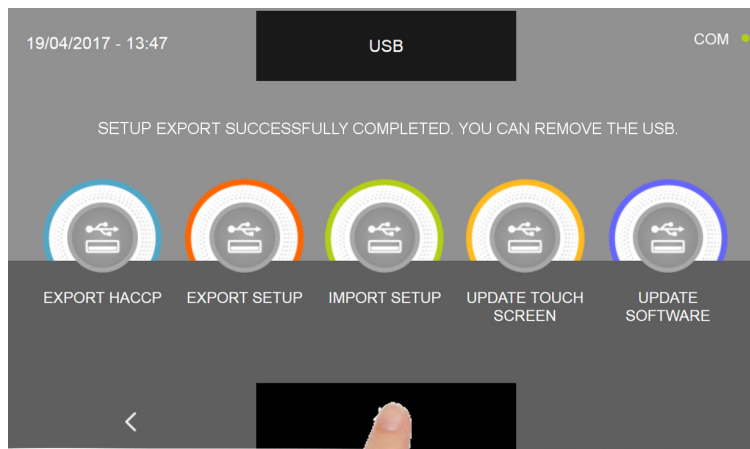
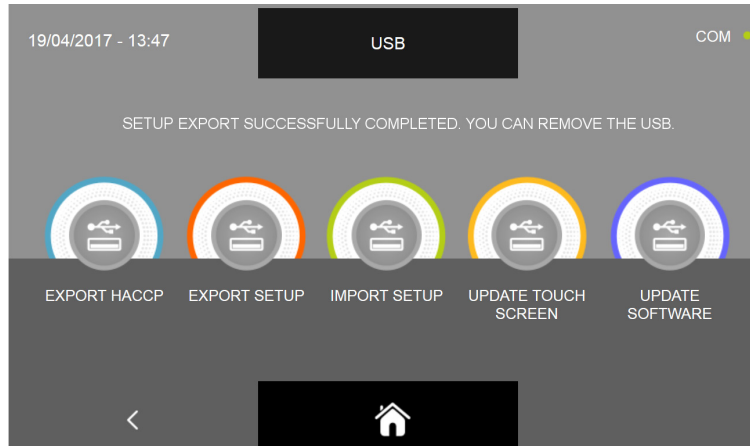

Press the icon  to go back to the HOME PAGE and only then, remove the pen drive.

The saved file has the *.sqlite format and can be imported only on multi-purpose balst chiller EVOLUTION series.

MULTI-PURPOSE BLAST CHILLER EVOLUTION

17.6.3 - IMPORT SETUP

N.B. FOR THIS FUNCTION IT IS NECESSARY TO INSERT A USB PEN DRIVE FORMATTED WITH FAT32 FILE SYSTEM WITH LOADED ONLY AND EXCLUSIVELY THE DATA EXPORTED FROM ANOTHER MULTI-PURPOSE BLAST CHILLER.

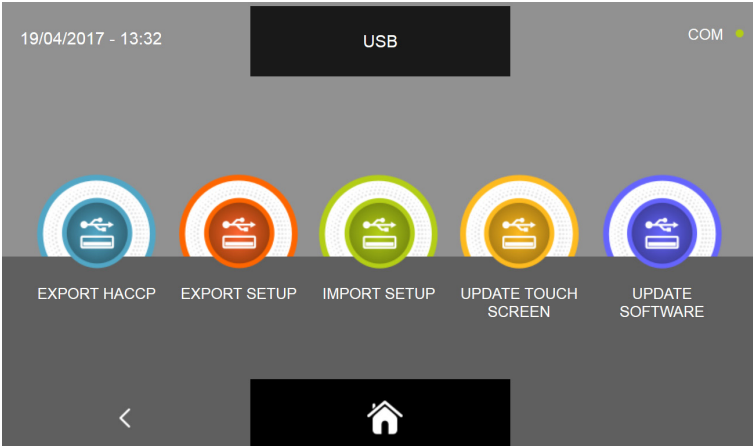

From the USB sub menu, press the IMPORT SETUP icon

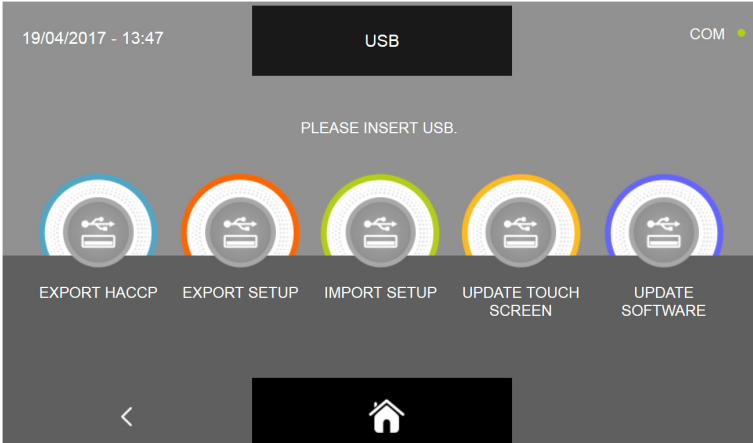

It is required to insert the pen drive into the appropriate panel connector

Open the protection cap of the USB connector and insert the pen drive.



MULTI-PURPOSE BLAST CHILLER EVOLUTION

When the insertion of the pen drive is detected, the download will automatically start and finish.

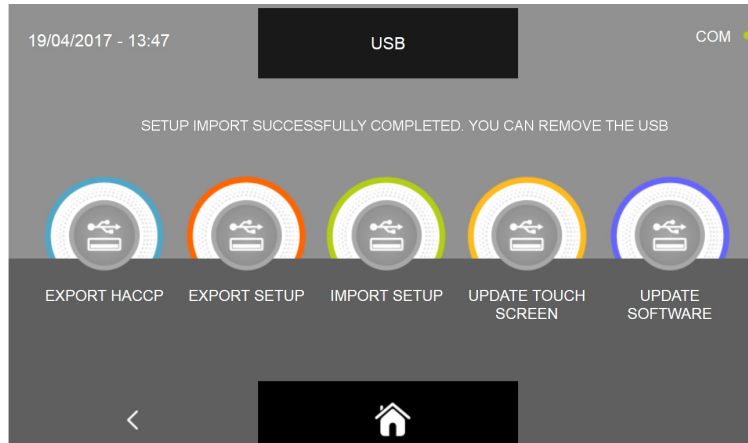

In order to load and store the custom programs saved on another machinery, the multi-purpose blast chiller will shutdown and turn on automatically till the HOME PAGE screen. Only when the procedure is completed, remove the pen drive from the USB connector.

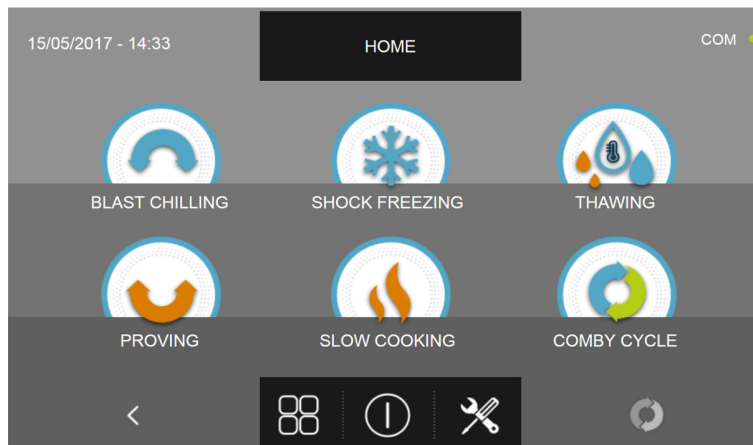

MULTI-PURPOSE BLAST CHILLER EVOLUTION

17.6.4A - UPDATE TOUCH SCREEN

From the USB menu it is possible to update the display (TOUCH SCREEN) and the main power board (CONTROLLER) firmware: Please note that the firmware update must necessarily be executed in Display - Controller sequence in order to avoid errors of communication / operation of the machinery.



From the USB sub menu, press the UPDATE TOUCH SCREEN icon



It is required to insert the pen drive into the appropriate panel connector
Open the protection cap of the USB connector and insert the pen drive with the update firmware only.



MULTI-PURPOSE BLAST CHILLER EVOLUTION



The procedure is automatic and will install all the required files.



The procedure will automatically end highlighting in green the files that are correctly installed. The machinery will shutdown and turn on automatically till the HOME PAGE screen.

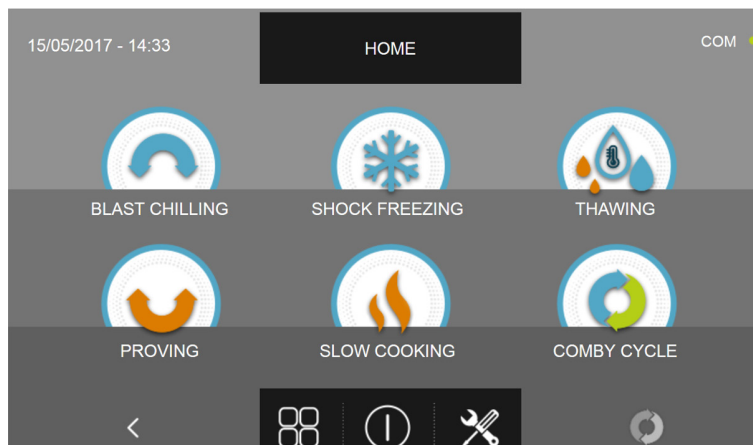

Once completed the touch screen update it is possible to proceed in upgrading the controller firmware.

N.B. FOR THE FIRMWARE UPDATE FUNCTION IT IS NECESSARY TO INSERT A USB PEN DRIVE FORMATTED WITH FAT32 FILE SYSTEM WITH LOADED ONLY AND EXCLUSIVELY THE UPDATE FIRMWARE, WITHOUT THEN ANY PREVIOUSLY STORED FILES.

17.6.4B - UPDATE SOFTWARE

From the USB menu it is possible to update the display (TOUCH SCREEN) and the main power board (CONTROLLER) firmware: Please note that the firmware update must necessarily be executed in Display - Controller sequence in order to avoid errors of communication / operation of the machinery.



From the USB sub menu, press the UPDATE SOFTWARE icon

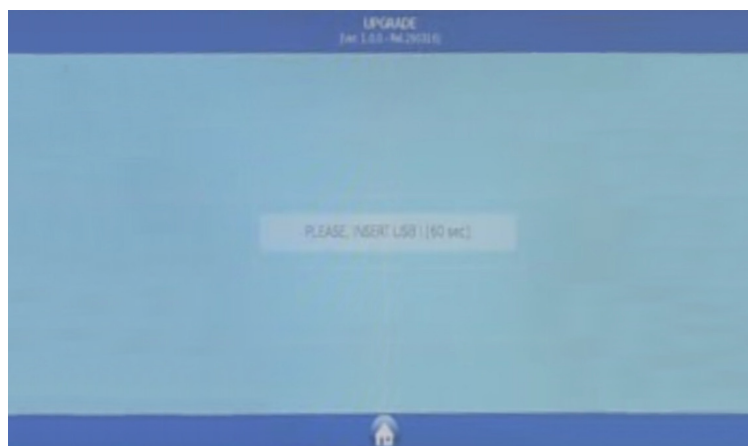

It is required to insert the pen drive into the appropriate panel connector
Open the protection cap of the USB connector and insert the pen drive with the update firmware only.



MULTI-PURPOSE BLAST CHILLER EVOLUTION



You are prompted for which machine to initialize the firmware, choose the icon specific to your machinery



Begin the update procedure by pressing the icon START



The procedure will end automatically, below is the color legend for the file update status :

COLOR	DESCRIPTION	ACTION REQUESTED
Green	Firmware component installed correctly	no action required
Yellow	Firmware component being installed	please wait, no action required up to now
Red	Firmware component not installed correctly	repeat the firmware installation procedure. For the multimedia MPG files no action required.

MULTI-PURPOSE BLAST CHILLER EVOLUTION

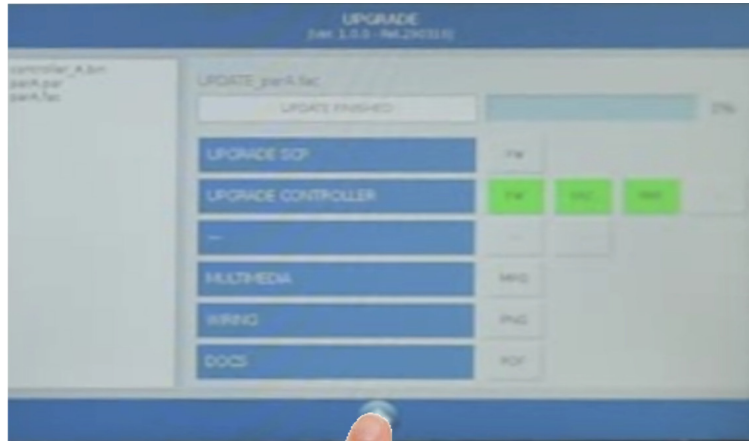

Press the icon to go back to the previous update page

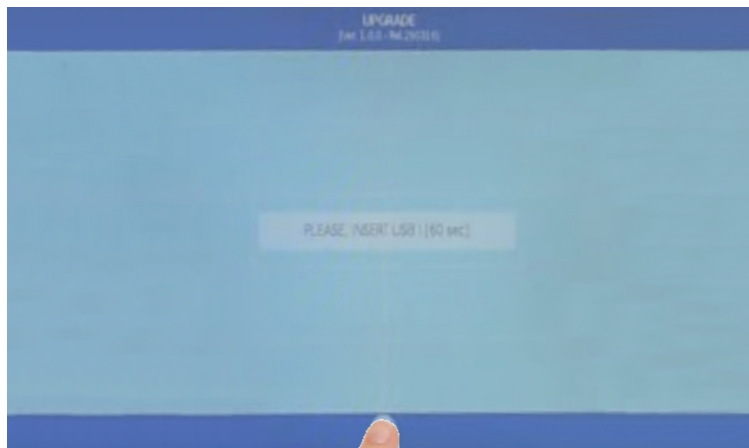

Press the icon to exit the update procedure

MULTI-PURPOSE BLAST CHILLER EVOLUTION



Confirm the intention to exit the upgrade procedure as indicated in the above picture

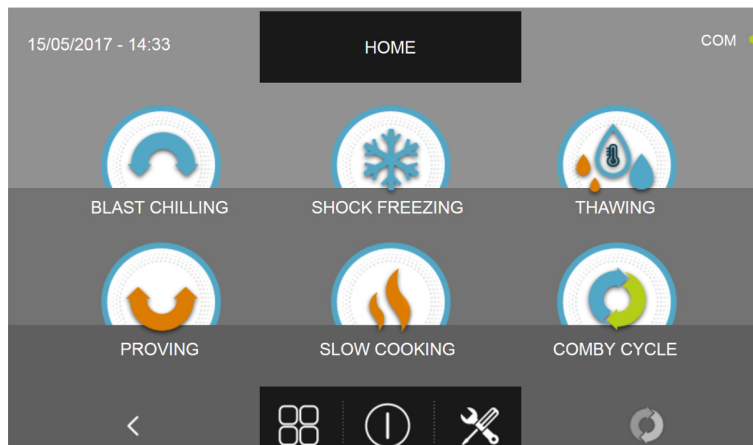

The machinery will shutdown and turn on automatically till the HOME PAGE screen. It will be then possible to remove the pen drive and start using the multi-purpose blast chiller.

If your machinery had some optional installed, for example the sterilizer, those optional functions should be activated again. The correct activation procedure is explained in the SERVICE chapter.

N.B. FOR THE FIRMWARE UPDATE FUNCTION IT IS NECESSARY TO INSERT A USB PEN DRIVE FORMATTED WITH FAT32 FILE SYSTEM WITH LOADED ONLY AND EXCLUSIVELY THE UPDATE FIRMWARE, WITHOUT THEN ANY PREVIOUSLY STORED FILES.

MULTI-PURPOSE BLAST CHILLER EVOLUTION

17.7 - HELP

This menu allows to run some help videos on how to perform the various cycles of the multi-function blast chiller.



From the HOME PAGE, press the icon  to access the Option menu.

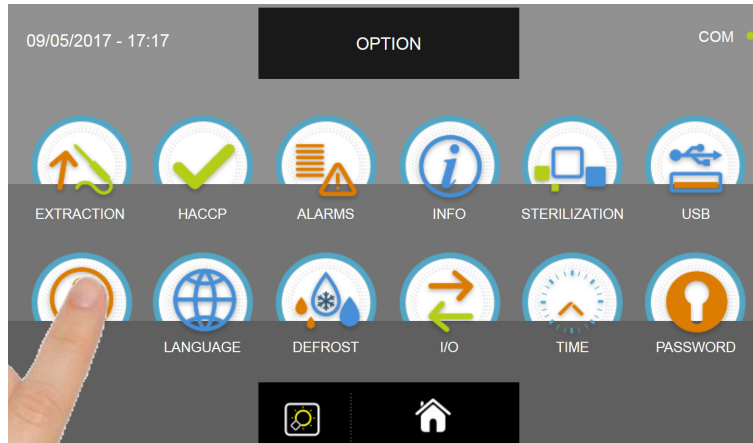
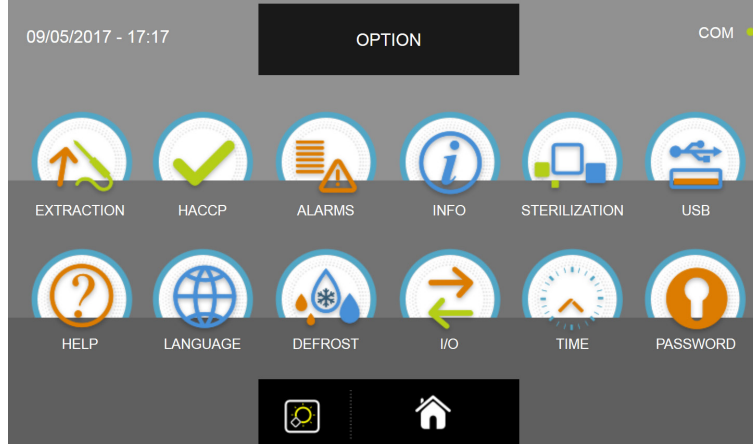

From the OPTION menu, press the HELP icon to access the video

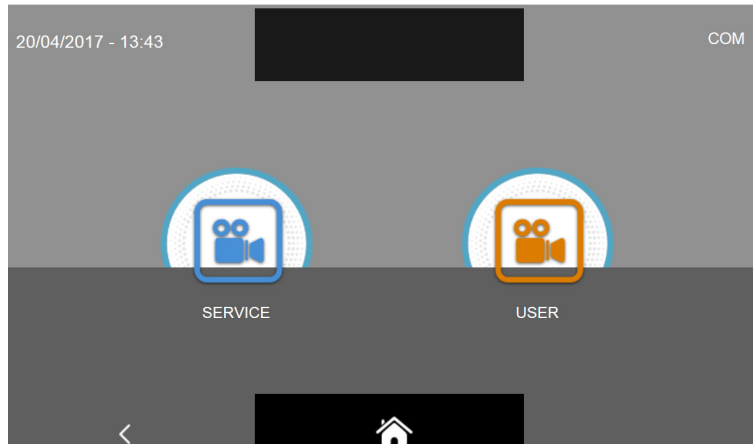

You are prompted two video categories :
SERVICE = video on how to perform the after-sales service operations
USER = video on how to perform the cycles and the options

To be noted that the SERVICE video are protected with a password and are meant only for the personnel of the after sales service. The service video will be described in the SERVICE chapter.

MULTI-PURPOSE BLAST CHILLER EVOLUTION

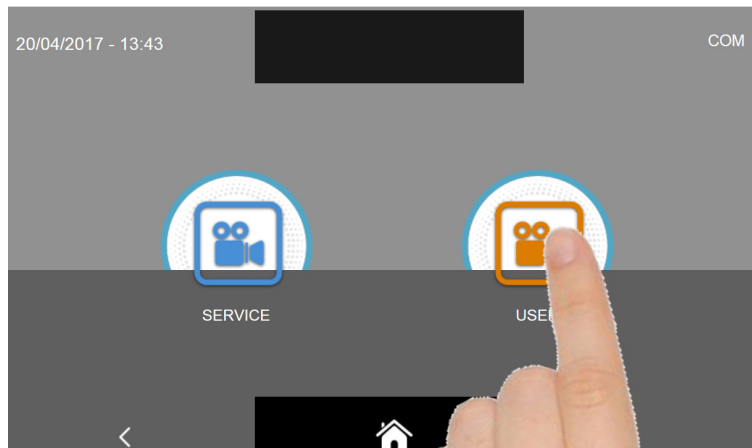

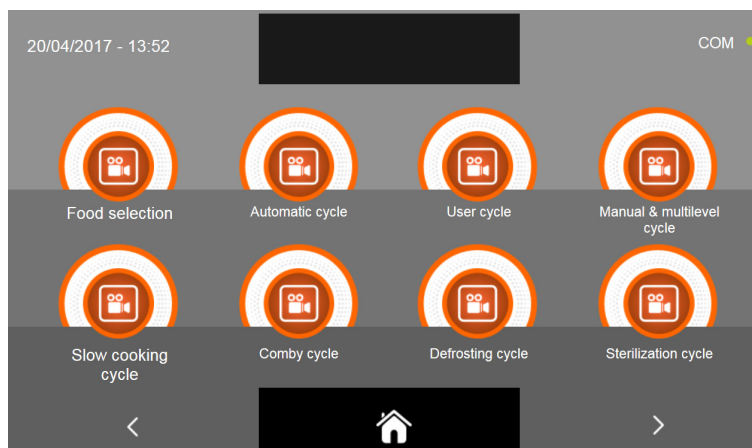

Select the desired type of video by pressing the relative icon



Select the video of interest

Press the icon  to proceed to the video second page.

Press the icon  to go back to the video category selection page.

Press the icon  to go back to the HOME PAGE.

MULTI-PURPOSE BLAST CHILLER EVOLUTION

17.8 - LANGUAGE

This menu allows to set the display language. The available languages are the following:

ITALIAN	ENGLISH	FRENCH	DEUTSCH	SPANISH	RUSSIAN	SLOVENIAN	CZECH	POLISH
---------	---------	--------	---------	---------	---------	-----------	-------	--------





From the HOME PAGE, press the icon  to access the Option menu.

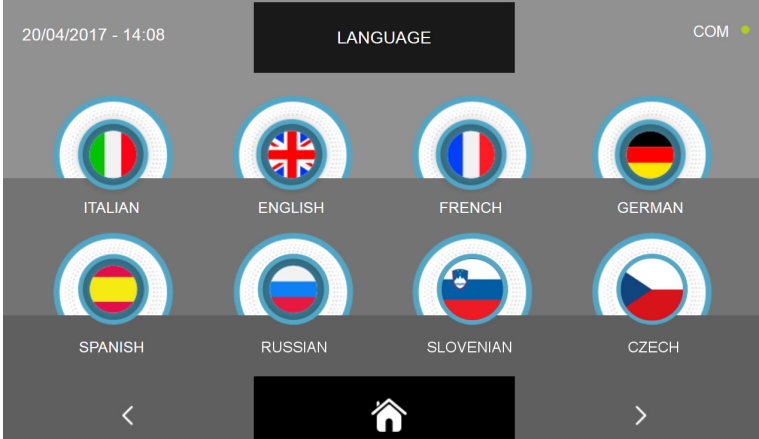

From the OPTION menu, press the LANGUAGE icon to access the language page.



Select the preferred language by clicking on the chosen flag icon.

Press the icon  to go back to the HOME PAGE. Press the icon  to go back to the option menu. Press the icon  to proceed to the next page with other available languages.

17.9 - DEFROST

This menu allows to perform a defrosting cycle which is necessary to clean the evaporator and is available only by forced air.

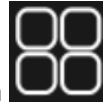

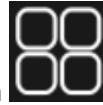
From the HOME PAGE, press the icon  to access the Option menu.

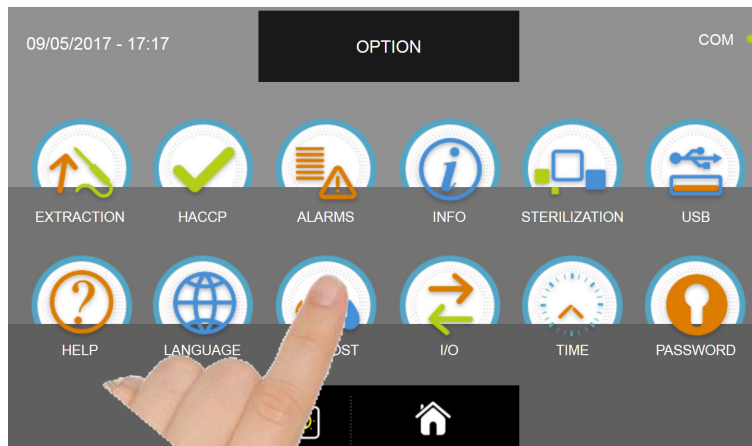
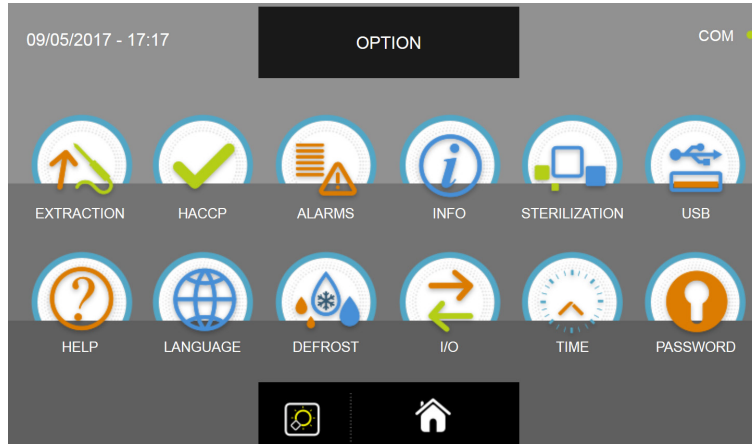

From the OPTION menu, press the DEFROST icon to start the cycle

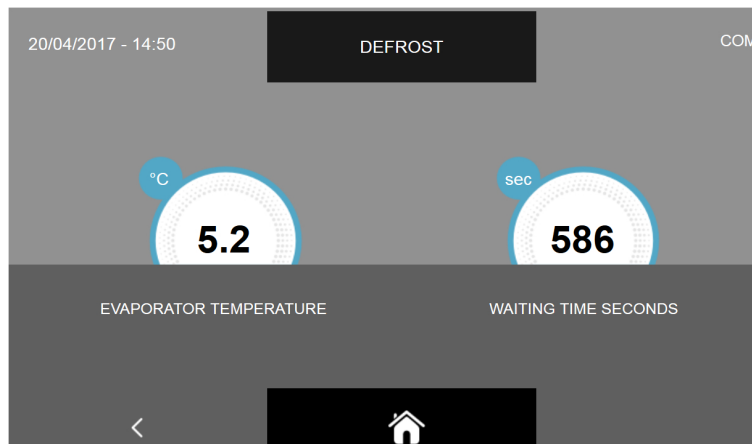



The defrosting cycle is a manual cycle which lasts 600 seconds.

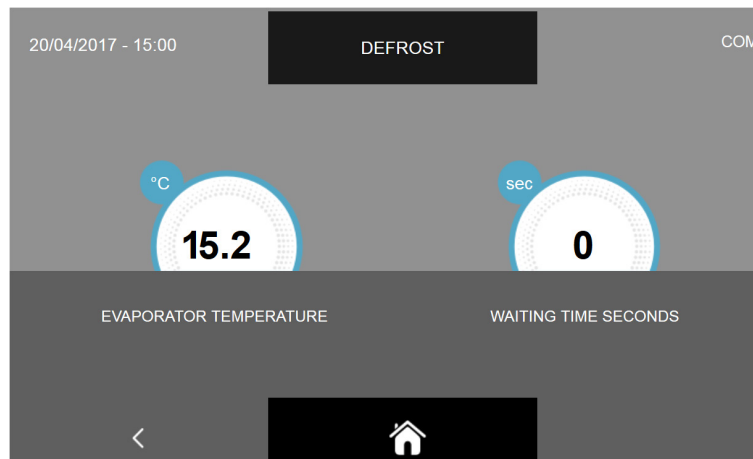

N.B. During the preservation cycles, the multi-purpose blast chiller perform an automatic defrosting cycle every 12 hours.

For manual defrosting cycles, it is advisable to perform at least one after each blast chilling cycle.

MULTI-PURPOSE BLAST CHILLER EVOLUTION



When the cycle is finished, meaning when the timer indicates 0 seconds left, press the icon  to go back to the option selection page or press the icon  to go back to the HOME PAGE.

It is possible to stop the execution of the manual defrost cycle in any moment by pressing either the icon  or , with the effects described above.

MULTI-PURPOSE BLAST CHILLER EVOLUTION

17.10 - I/O

This menu allows to display the I/O, the input and output connected with the main power board in the electrical compartment.

Knowing the probes values and the state of the various inputs of the main electronic board is very useful to understand the operation of the multi-purpose blast chiller, to have a general overview of the status of the various components installed (eg. temperature probes) and is very useful for providing more information when requesting technical assistance.

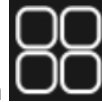

From the HOME PAGE, press the icon  to access the Option menu.

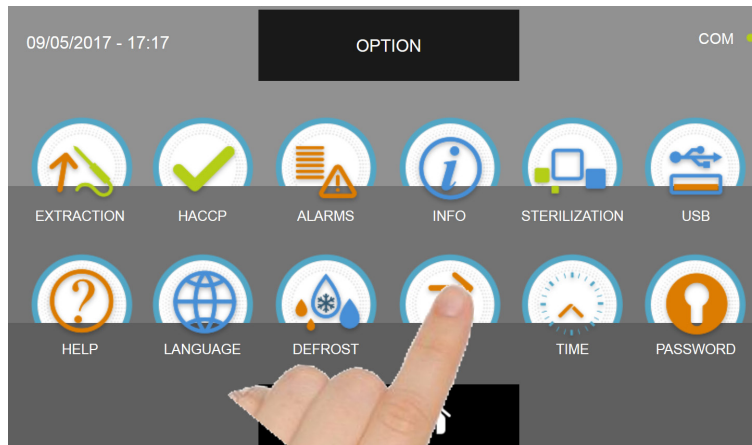
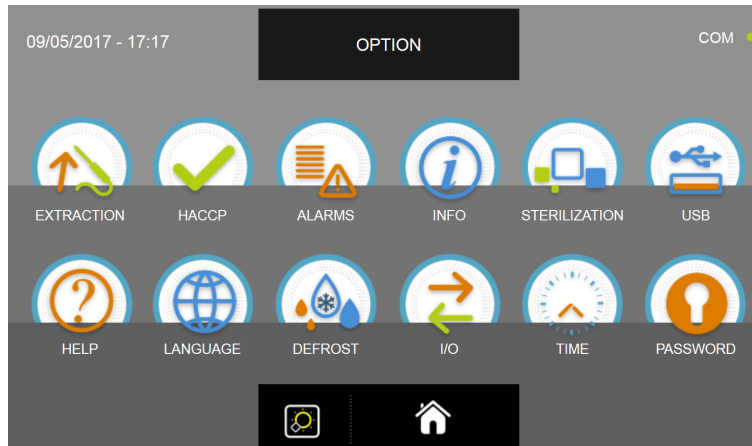

From the OPTION menu, press the I/O icon to access the information page

FOOD PROBE 1	13.5 °C	DOOR SWITCH	CLOSED
FOOD PROBE 2	13.9 °C	MAGNETOTHERMIC	OFF
FOOD PROBE 3	14.3 °C	HIGH PRESSURE SWITCH	OFF
FOOD PROBE 4	13.5 °C	LOW PRESSURE SWITCH	OFF
AIR PROBE	9.9 °C	OUTPUTS	01000010
EVAPORATOR PROBE	5.2 °C	KRIWAN	OFF
CONDENSER PROBE	29.3 °C	VENTILATION	10
OVERHEATING PROBE	---	CONSUMPTION	1548 W
PRESSURE PROBE	---	HUMIDITY PROBE	-%
OVERHEATING	---		

MULTI-PURPOSE BLAST CHILLER EVOLUTION

The values and the data that can be read in the I/O chart are the following:

NAME	DESCRIPTION	RANGE
Food probe 1	Temperature point 1	-55°C ÷ +105°C resolution 0.1°C
Food probe 2	Temperature point 2	-55°C ÷ +105°C resolution 0.1°C
Food probe 3	Temperature point 3	-55°C ÷ +105°C resolution 0.1°C
Food probe 4	Temperature point 4	-55°C ÷ +105°C resolution 0.1°C
Air probe	Cell temperature	-49.9°C ÷ +99.9°C resolution 0.1°C
Evaporator probe	Evaporator temperature	-49.9°C ÷ +99.9°C resolution 0.1°C
Condenser probe	Condenser temperature	-49.9°C ÷ +99.9°C resolution 0.1°C
Overheating probe	VTE temperature (optional)	-49.9°C ÷ +99.9°C resolution 0.1°C
Pressure probe	VTE pressure (optional)	(0/5V = -1/4.2bar) resolution 1,2%
Overheating	VTE differential temperature (optional)	+2°C ÷ +15°C
Door switch	Sensor status	Open/Closed
Magnetothermic	Switch status	OFF/ON
High pressure switch	Pressure switch status	OFF/ON
Low pressure switch	Pressure switch status	OFF/ON
Outputs	Outputs status	1=Active 0=Not active
Kriwan	Compressor protection status	OFF/ON
Ventilation	Evaporator fan speed	1-10
Consumption	Current power absorption	0-10000 Watt
Humidity probe	Cell humidity value	15-95% UHR



Press the icon  to go back to the previous option selection page or press the icon  to go back to the HOME.



17.11 - TIME

This menu allows to set the date and time to be displayed in the upper left area of the screen. To be noted that this operation is necessary to correctly record the information for the HACCP reports.



From the HOME PAGE, press the icon  to access the Option menu.

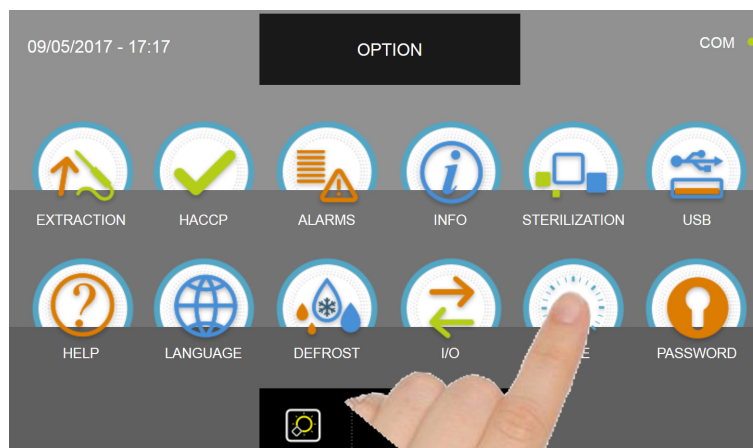
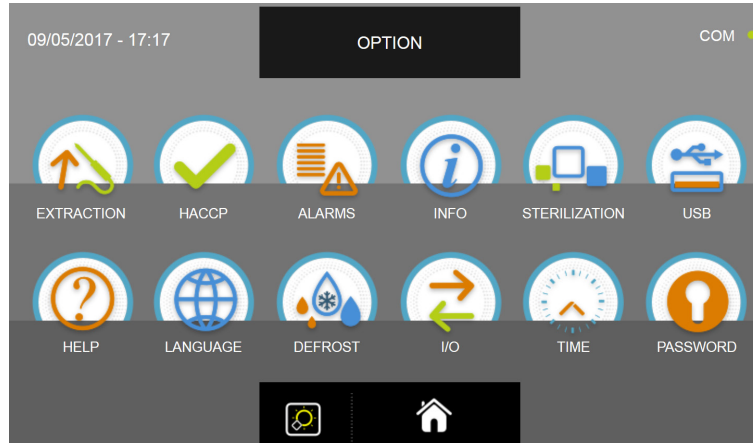

From the OPTION menu, press the icon DATE to access the setting page

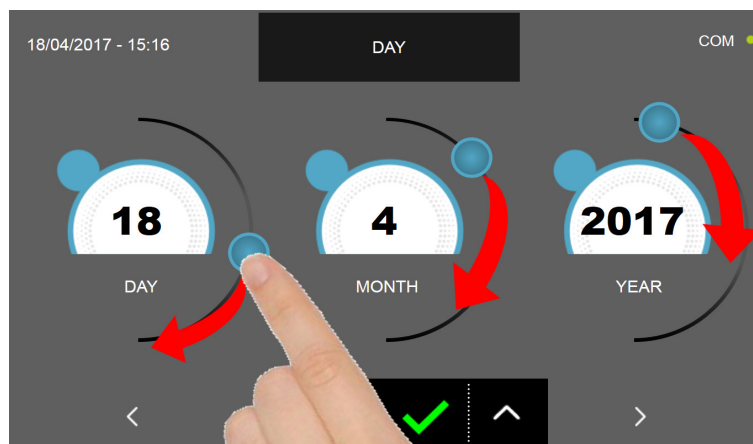

Set the date by moving the cursors as indicated in the picture, or select the desired field and set the values with the icons



and . Press the icon  to proceed to the time setting page.

MULTI-PURPOSE BLAST CHILLER EVOLUTION

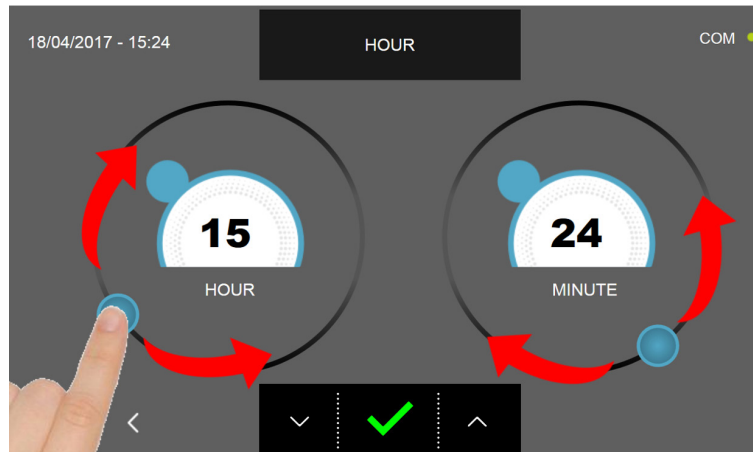

Set the time by moving the cursors as indicated in the picture, or select the desired field and set the values with the icons



Press the icon  to save and set the date and time.

Press the icon  to go back to the date setting page or, if pressed a second time, to the option selection menu, in this case the settings will not be saved.

17.12 - PASSWORD

This menu allows to set the machinery access password (the value 0000 indicates that the password is not set) :

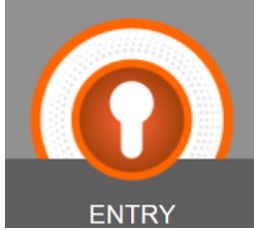

ENTRY

ENTRY : password that prevents the machinery to be used by not authorized personnel; it protects the access to the HOME PAGE and needs to be input when turning on the machinery from the stand-by mode.



CHEF

CHEF: password of a higher level than the ENTRY level, it gives access to all the menu not available with an ENTRY level and in addition allows to protect the “custom cycles” settings.

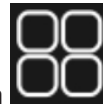

From the HOME PAGE, press the icon  to access the Option menu.

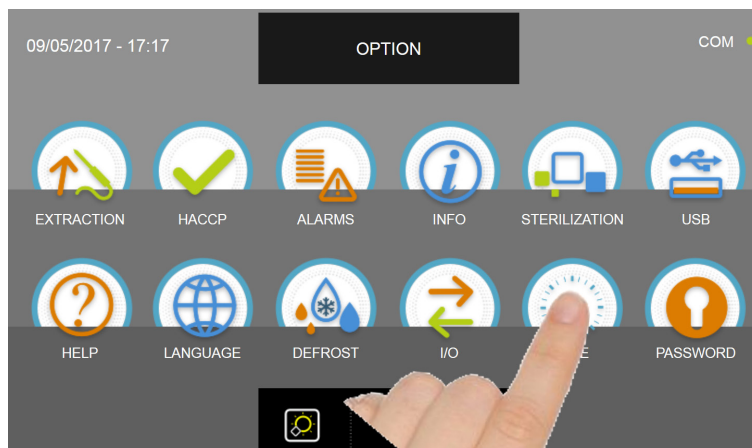
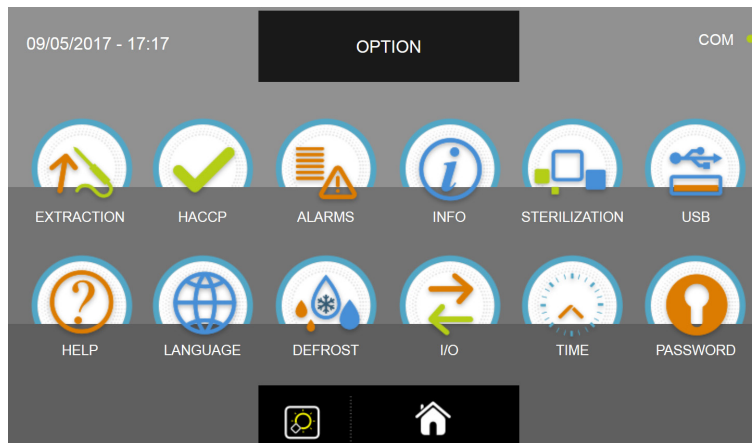

From the OPTION menu, press the PASSWORD icon to access to the security level selection

MULTI-PURPOSE BLAST CHILLER EVOLUTION

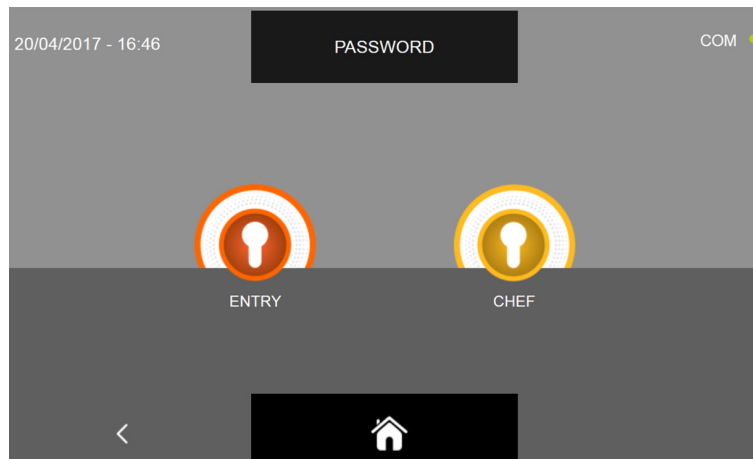

The procedure to set the password is identical for both the choices, therefore only one will be shown

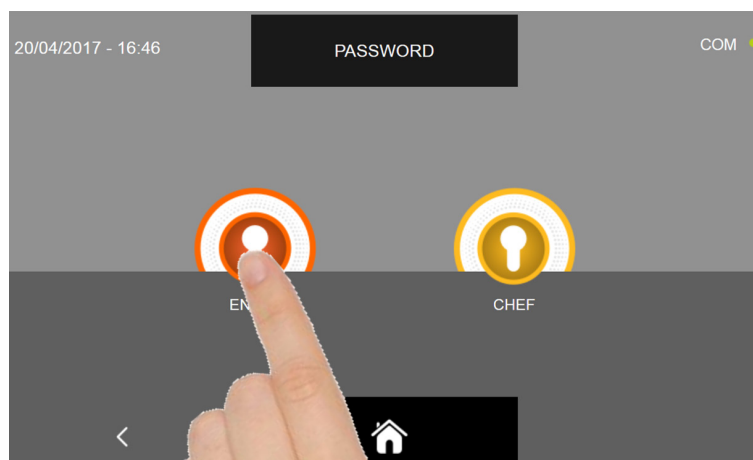

Select the desired security level

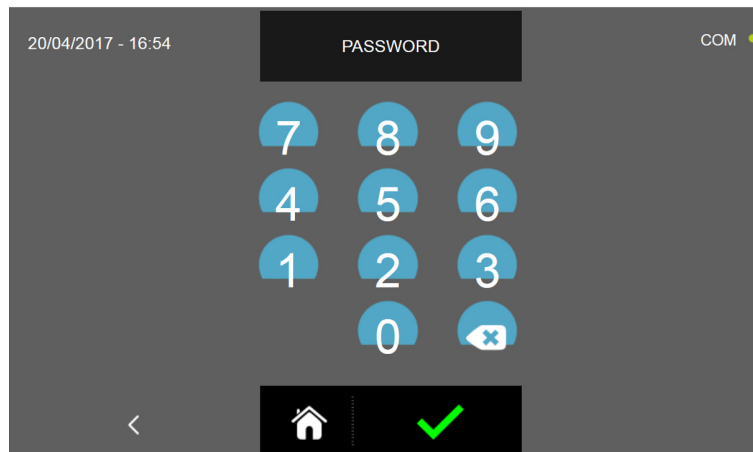

You are prompted to the keypad page. The password must be composed of 4 numeric characters.

MULTI-PURPOSE BLAST CHILLER EVOLUTION

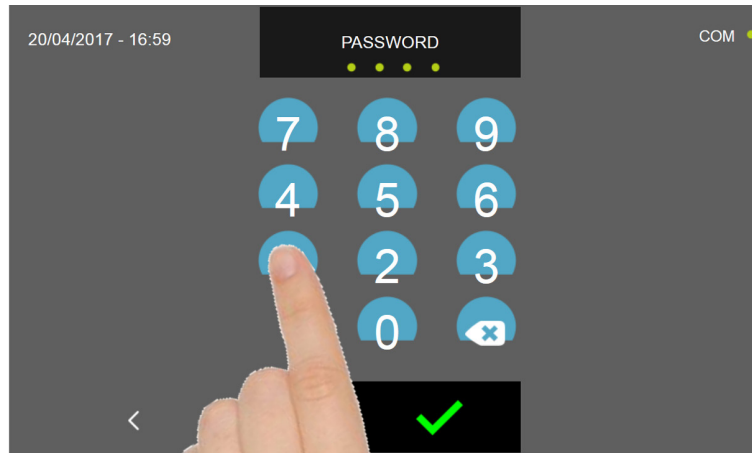

Insert the password by pressing the keypad.



The insertion of each number is highlighted by the icon under the word PASSWORD.



The icon indicates that all 4 digits have been selected.



Press the icon to erase any of the input numbers.



Press the icon to save and set the password.



Press the icon to go back to the security level choice page and if the icon is pressed again to go back to the option selection menu. In both these cases the password will not be saved.



Press the icon to go back to the HOME PAGE, even in this case the password will not be saved.

Troubleshooting

18- ALARMS LIST

If there is a malfunction, the user will be notified by the buzzer. The buzzer can be silenced by pressing the  key which is located in the upper right display section and opening the alarm list screen.

To delete the alarm, the user must exit the current procedure and place the display in STAND-BY mode.

The alarm status will remain until the cause of the alarm has been eliminated.

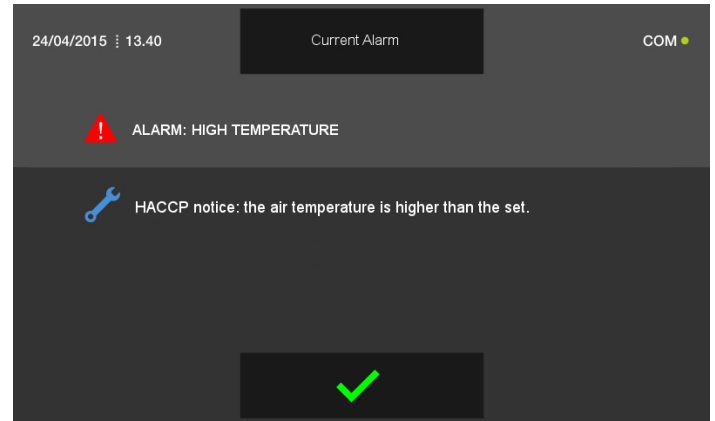
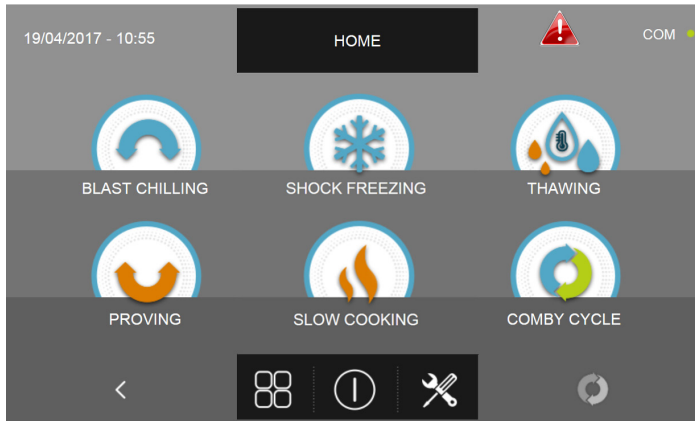

Following is a table listing the possible alarms in the event of a machine malfunction:

SITUATION	ERROR SHOWN ON DISPLAY	POSSIBLE REASON	USER SOLUTION
Red triangle	Alarm: Maintenance	Maximum time elapsed without maintenance/cleaning	Clean condenser. Call a qualified technician for a general machine inspection
Red triangle and machinery in lock mode	Alarm: Condenser high temperature	High room temperature	Ventilate the room, clean the condenser and free any air inlets. If the problem persists, contact a qualified technician
		Condenser clogged / dirty	
Red triangle	Alarm: Evaporator low temperature	Ice on evaporator	Perform an additional defrosting cycle
Red triangle	Alarm: Defrosting time-out	Ice on evaporator	Perform an additional defrosting cycle or leave the machine in stand-by for 12 hours with the door open. If the problem persists, contact a qualified technician
Red triangle	Alarm: Door 1 open	Maximum allowed time for open door elapsed. Close the door	Close the door. If the problem persists, contact a qualified technician
Red triangle and machinery in lock mode	Alarm: Electrical feeding	Check the electrical power supply voltage	Contact a qualified technician

MULTI-PURPOSE BLAST CHILLER EVOLUTION

SITUATION	ERRORSHOWNONDISPLAY	POSSIBLE REASON	USER SOLUTION
Red triangle	Alarm: Food probe not inserted !	Food probe test failed	Insert the probe into the food. If the problem persists, contact a qualified technician.
	Alarm: Preservation	The temporary preservation cycle is about to end.	Remove the product from the blast chiller and stop the cycle.
	Alarm: Low temperature	HACCP alarm: air temperature too low compared to set value.	Turn the machine off and then on again. If the problem persists, contact a specialised technician
	Alarm: High temperature	HACCP alarm: air temperature too high compared to set value.	Turn the machine off and then on again, and perform a defrosting cycle. If the problem persists, contact a qualified technician.
	Alarm: Air probe (S1)	Cell probe damaged or broken	Contact a qualified technician
	Alarm: Evaporator probe (S2)	Evaporator probe damaged or broken	Contact a qualified technician
	Alarm: Condenser probe (S3)	Condenser probe damaged or broken	Contact a qualified technician
Red triangle and machinery in lock mode	Overheating probe (SAUX) alarm	Overheating probe damaged or broken	Contact a qualified technician
Red triangle	Alarm: Food probe (PT1)	Food probe damaged or broken	Contact a qualified technician
	Alarm: Food probe (PT2)	Food probe damaged or broken	Contact a qualified technician
	Alarm: Food probe (PT3)	Food probe damaged or broken	Contact a qualified technician
	Alarm: Food probe (PT4)	Food probe damaged or broken	Contact a qualified technician
	Alarm: Pressure probe (RH%)	Pressure probe damaged or broken	Contact a qualified technician
	Alarm: Humidity probe (RH%)	Humidity probe damaged or broken	Contact a qualified technician
	Alarm: Black out	No power supplied during cycle	Restore the power supply to the machine
	Alarm: Black out ended	Indication that a black out alarm occurred	---
	Alarm: Magnetothermic	---	Contact a qualified technician
	Alarm: Kriwan (for 1Hundred it indicates water drain pump alarm)	---	Contact a qualified technician
	Alarm: High pressure	Ambient temperature too high	Clean condenser. If the problem persists, contact a qualified technician
	Alarm: Low pressure	---	Contact a qualified technician

If assistance by a qualified technician is requested, the following information must be provided :

Error message

Serial number of machine

SCAN TO DISCOVER MORE INFORMATION!

